

# LED Lighting Catalogue

Household Lights & Hotel Lights 2022

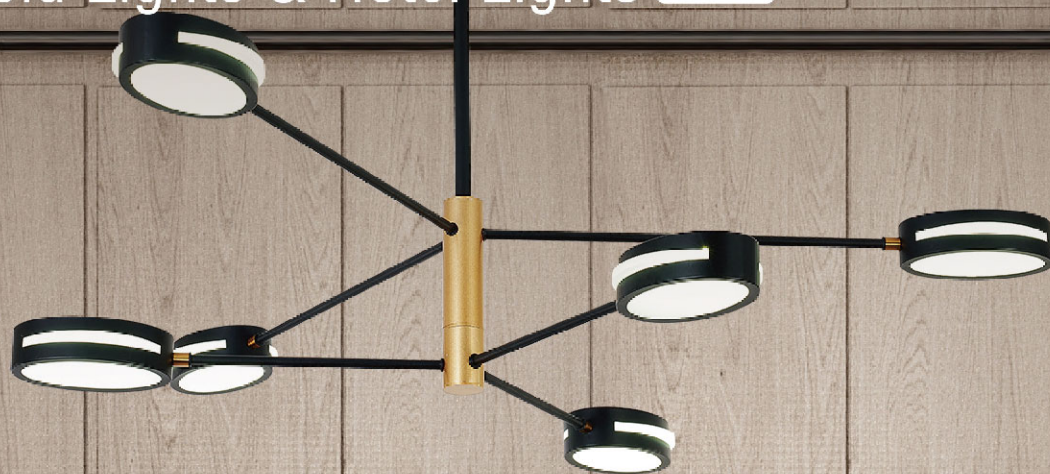

**ERIK C**<sup>®</sup>  
concepts





Chandeliers



# Chandeliers **NEW**



**MP1222**

Voltage: 220-240V  
Wattage: Max 40W  
Base: E27  
Material: Metal  
**IP20**



**MP1223**

Voltage: 220-240V  
Wattage: Max 40W  
Base: E27  
Material: Metal  
**IP20**



**MP1224**

Voltage: 220-240V  
Wattage: Max 40W  
Base: E27  
Material: Glass  
**IP20**

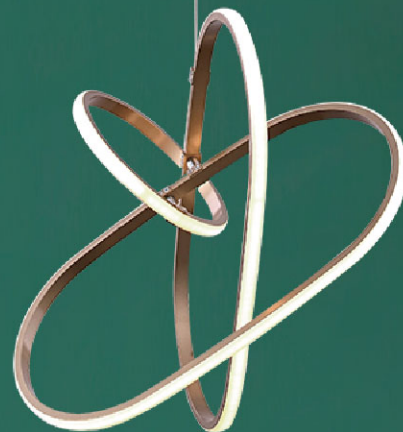

**MP1225**

Voltage: 220-240V  
Wattage: 38W  
SMD 2835  
Material: Alu.+silicone  
**IP20**





# Chandeliers



HP1223-4



PMMA+Iron+Alu.



HP1223-6



PMMA+Iron+Alu.



HP1223-8



PMMA+Iron+Alu.





# Chandeliers



HP1224-6



PMMA+Iron



HP1224-8



PMMA+Iron



HP1224-10



PMMA+Iron





# Chandeliers

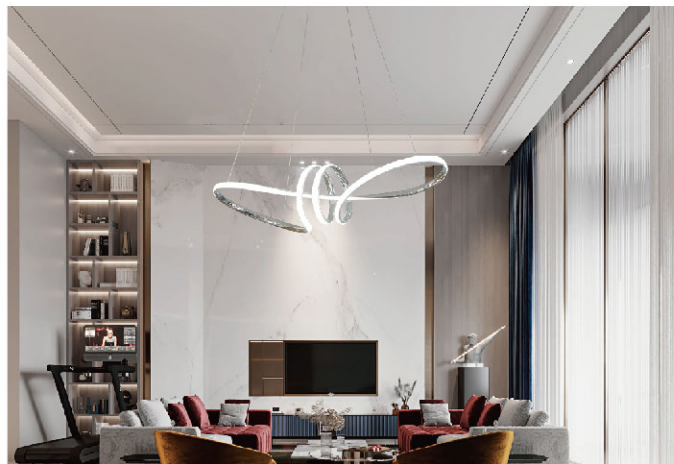

HP1225



Silicone+Alu.



HP1226



PMMA+Iron+Alu.



HP1227



PMMA+Iron+Alu.



HP1228



PMMA+Iron+Alu.





# Chandeliers



## FCH1003-1





  
 SMD 100~ 30W Ra≥80 1500  
 2835 240V

Iron+Alu.+Acrylic

Size: 1065\*80\*1500mm

CE  

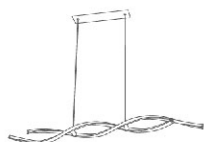

## HP1230





  
 SMD 100~ 30W Ra≥80 1500  
 2835 240V

Alu.+Silicone

Size: Ø800\*1200mm

CE 



## HP1124





  
 SMD 100~ 30W Ra≥80 1500  
 2835 240V

Alu.+Silicone

Size: 1000\*400\*1200mm

CE 





# Chandeliers

---



**MP1284**

**Voltage:** 100-240V

SMD2835

**Wattage:** 84W

**Material:** metal+cloth

Ra≥80

**Lumen:** 1500lm



**HP1240**

**Voltage:** 100-240V

SMD2835

**Wattage:** 84W

**Material:** metal+cloth

Ra≥80

**Lumen:** 1500lm





## Chandeliers

---



HP1237

Voltage: 100-240V

Wattage: 84W

SMD 2835

Material: Alu.+silicone

Lumen: 1500lm





# Chandeliers

---



**HP2085**  
**Voltage:** 100-240V  
**SMD2835**  
**Wattage:** 11W  
**Material:** Iron+PC+Crystal  
**Ra**≥80  
**Lumen:** 1500lm



**HP2085**  
**Voltage:** 100-240V  
**SMD2835**  
**Wattage:** 11W  
**Material:** Iron+PC+Crystal  
**Ra**≥80  
**Lumen:** 1500lm





# Chandeliers



## HP1031-2

      
SMD 175~ 3\*15W Ra≥80 3375  
2835 240V

Iron+Alu.+Acrylic Size: Ø680\*1000mm  
White/Grey/Black



## HP1031-1

      
SMD 175~ 15W Ra≥80 1125  
2835 240V

Iron+Alu.+Acrylic Size: 250\*250\*1000mm  
White/Grey/Black



## HP1031-3

      
SMD 175~ 3\*15W Ra≥80 3375  
2835 240V

Iron+Alu.+Acrylic Size: Ø350\*1000mm  
White/Grey/Black





# Chandeliers



HP1024



Alu.+Wood



HP1024-1

Size: Ø350\*380mm

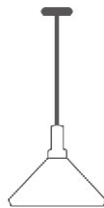

HP1024-2

Size: Ø240\*420mm



HP1024-3

Size: Ø350\*440mm

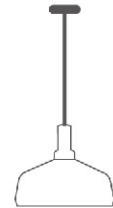



# Chandeliers



HP1026

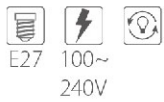

Alu.+Wood



HP1026-1

Size: Ø300\*205mm  
 Size: Ø330\*250mm  
 Size: Ø420\*305mm

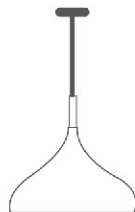

HP1026-2

Size: Ø320\*235mm  
 Size: Ø480\*350mm



HP1026-3

Size: Ø270\*340mm





# Chandeliers



HP1025

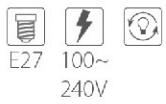

Alu.+Metal+Wood



HP1025-1

Size: Ø140\*400mm



HP1025-2

Size: Ø260\*400mm



HP1025-3

Size: Ø300\*150mm

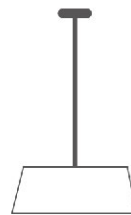

HP1025-4

Size: Ø270\*340mm

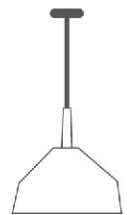



# Chandeliers



HP1035-1

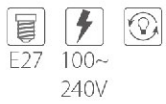

Iron+Alu.+wood



HP1035-1

Size: Ø190\*340mm

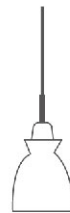

HP1035-2

Size: Ø280\*280mm

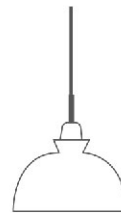

HP1035-3

Size: Ø250\*280mm

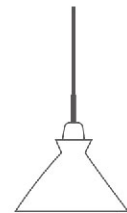



# Chandeliers



Metal+cloth



**HP1001**

Size: Ø380\*350mm  
Size: Ø450\*410mm

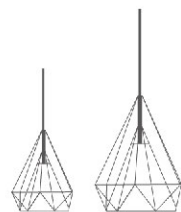

**HP1002**

Size: Ø250\*265mm



**HP1003**

Size: Ø250\*265mm



**HP1036**

Size: Ø360\*225mm





# Chandeliers









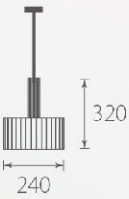

  
 E27 100~  
 240V

Iron  

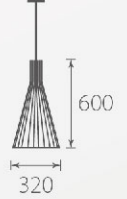

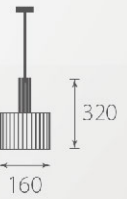
HP1179	HP1183	HP1180	HP1184	HP1181	HP1185	HP1182	HP1186
							
370 280	370 280	320 240	300 320	190 230	600 320	240 140	320 160

# Chandeliers



HP1015



HP1192



HP1193



HP1195



HP1187



HP1189



HP1194



HP1191



HP1188



HP1190



E27 100~240V



Iron

CE

HP1187 HP1015 HP1188 HP1192 HP1189 HP1193 HP1190 HP1194 HP1191 HP1195

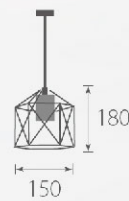



# Chandeliers

---



 Pull Switch

**Item No.:** MP1246-5

**Size:** 52"/ 1320mm

**Motor size:** AC 153\* 18

**Power:** 75W

**Blades Material:** Plywood/ 5PCS

**Light kit:** 3\* E26

**Color:** AB



 Remote Control

**Item No.:** MP1245-5

**Size:** 52"/ 1320mm

**Motor size:** AC 153\* 18

**Power:** 75W

**Blades Material:** Plywood/ 5 PCS

**Light kit:** LED 24W 3000K

**Color:** White, Santin Nickel

# Chandeliers

---



 Remote Control  Pull Switch

**Item No.:** MP1248-4  
**Size:** 52"/ 1320mm  
**Motor:** AC153\* 18  
**Power:** 70W  
**Blades Material:** Plywood/ 4pcs  
**Light kit:** LED 24W  
**Material:** Si-steel+ 100% copper



 Remote Control  Pull Switch

**Item No.:** MP1249-3  
**Size:** 46"/1220mm  
**Motor size:** AC153\*15  
**Power:** 65W  
**Blades Material:** ABS/3 pcs  
**Light kit:** LED 24W CCT  
**Color:** Matt Black /White



# Table & Floor Lamps

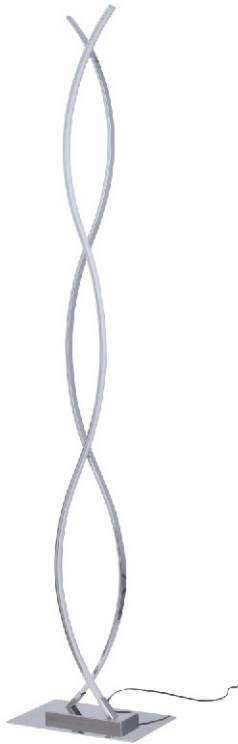

**FL1056**





  
 SMD 100~ 8W Ra>80 440  
 3014 240V

Iron+Alu.+Acrylic







**FL1082**



  
 E27 100~ Max. on-off  
 240V 40W





Cover: TC cloth

Holder+base: metal+wood





**FFL1003-2**





  
 SMD 100~ 24W Ra>80 1800  
 2835 240V

Iron+Alu.+Acrylic

Size: Ø200\*1345mm











# Table & Floor Lamps



## FL2069

     
E27 100~ Max. on-off  
240V 40W

Cover: TC cloth

Holder+base: metal+Wood

Size: 250\*350\*1630mm

CE



## FL2070

     
E27 100~ Max. on-off  
240V 40W

Cover: TC cloth

Holder+base: metal+Wood

Size: 400\*400\*1550mm

CE





# Table & Floor Lamps



**FL2071**

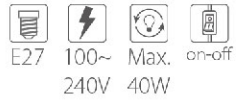

Cover: TC cloth

Base: wood+metal

Size: 400\*300\*1670mm

CE

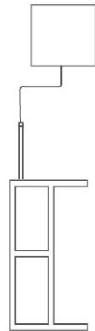

**FL2072**

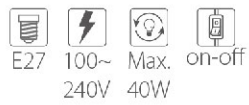

Cover: TC cloth

Wooden lamp legs

Iron tray

Size: 350\*350\*1550mm

CE



# Table & Floor Lamps



## FL2105

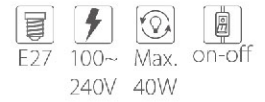

Cover: TC cloth

Holder+base: metal+wood

CE



## FL2106



Cover: TC cloth

Holder+base: metal+wood

CE







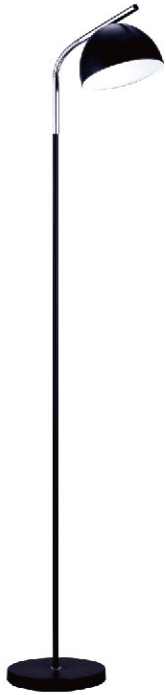

# Table & Floor Lamps



**FL1076**





     
E14 100~ Max. on-off  
240V 40W

Shade+base: metal+wood

CE



**FL1077**



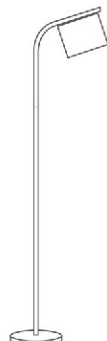

     
E14 100~ Max. on-off  
240V 40W

Shade+base: metal+wood

CE



**FL1053**

     
E14 100~ Max. on-off  
240V 40W

Shade+base: metal+wood

Size: Ø250\*1570mm

CE

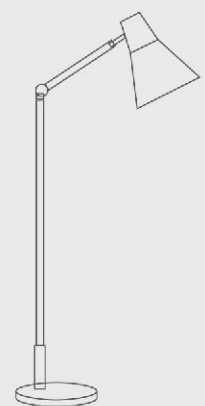

## Table & Floor Lamps

---



**FL1055**

     
E14 100~ Max. on-off  
240V 40W





Shade+base: metal+wood

Size: Ø140\*400mm

CE



**FL1054**

     
E14 100~ Max. on-off  
240V 40W

Shade+base: metal+wood

Size: 180\*240\*780mm

CE



**FL1056**

     
E14 100~ Max. on-off  
240V 40W

Shade+base: metal+wood

Size: Ø140\*460mm

CE



**FL1059**

     
E14 100~ Max. on-off  
240V 40W

Shade+base: metal+wood

Size: Ø140\*480mm



## Table & Floor Lamps

---

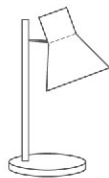

**FL1057**

     
E14 100~ Max. on-off  
240V 40W



Material: metal

Size: Ø180\*460mm

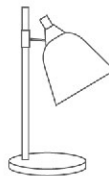
CE



**FL1058**

     
E14 100~ Max. on-off  
240V 40W

Material: metal

Size: Ø160\*460mm

CE





# Ceiling Lights





# Ceiling Lights **NEW**



- CCT adjustable by dial switch & color temperature optional
- 2-year warranty
- Non-isolated or DOB

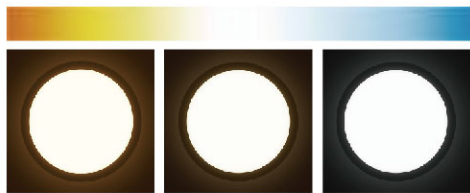

Item No.	Voltage [V]	Wattage [W]	Lumen [lm]	Ra	DF	Life time [H]	Material	Size [DxHmm]	Packing [Pcs / M <sup>3</sup> / KG]
CE2181C-20W2-G1	175-240	20	1600	≥80	>0.7	25000	PP	∅200 * 50	20/0.049/8.3
CE2181C-30W2-G1	175-240	30	2400	≥80	>0.7	25000	PP	∅300 * 50	10/0.054/6.7
CE2181C-40W2-G1	175-240	40	3200	≥80	>0.7	25000	PP	∅400 * 50	10/0.092/7.2



# Ceiling Lights **NEW**

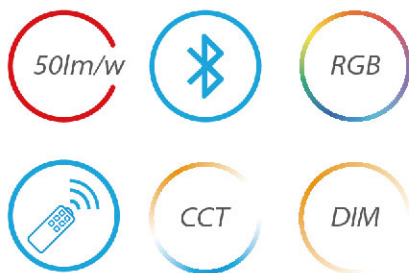
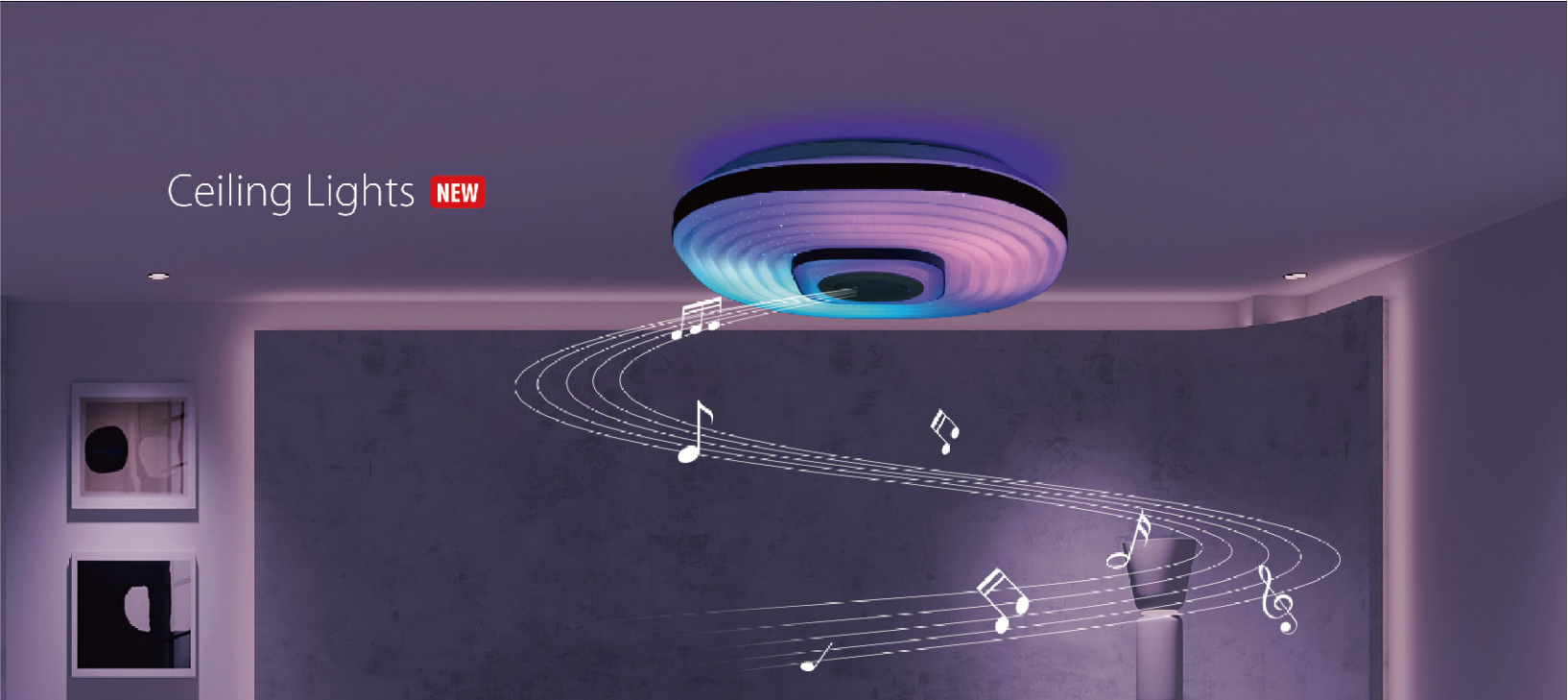

- Voltage resistance 1500V
- Dazzling light effects

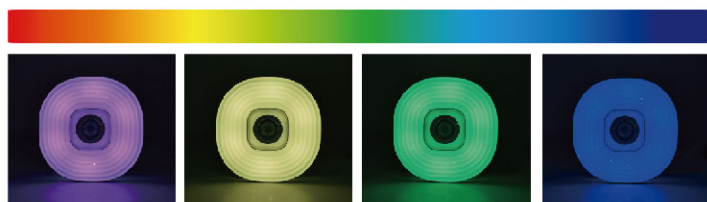

Item No.	Voltage [V]	Wattage [W]	Lumen [lm]	Ra	PF	Life time [H]	Material	Size [DxHmm]	Packing [Pcs / M <sup>2</sup> / KG]
CE2235	220-240	36	1800	≥80	>0.5	/	PVC+Iron	Ø380*70	1/0.106/9



# Ceiling Lights NEW

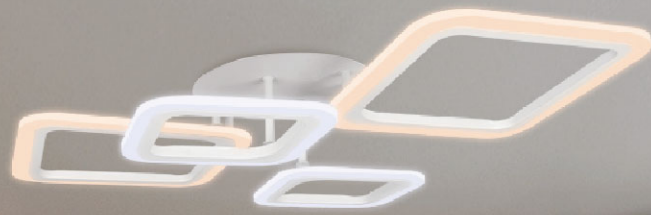

- 3 color temperature adjustable
- Dimming function

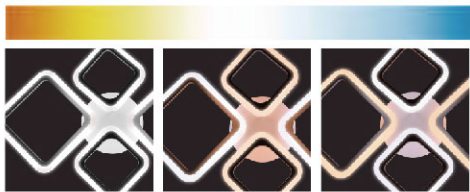
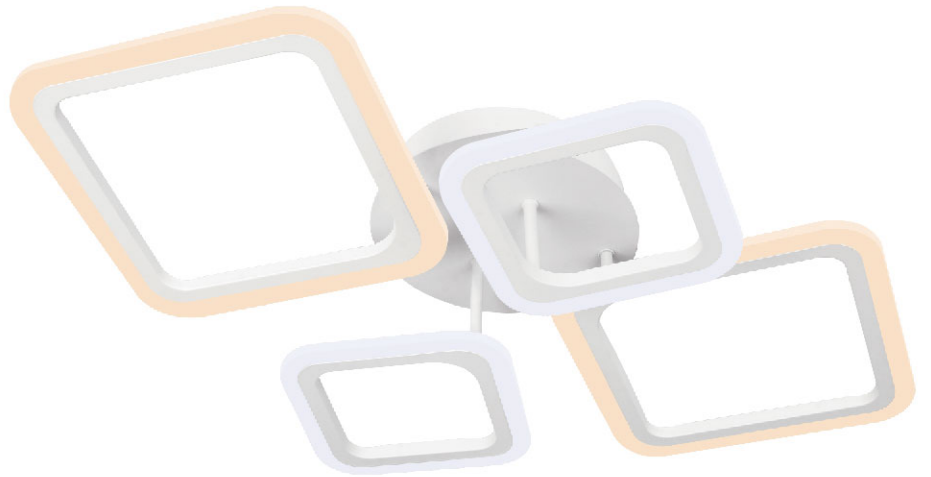
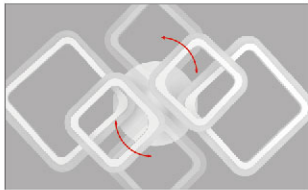

Item No.	Voltage [V]	Wattage [W]	Lumen [lm/W]	Ra	PF	Life time [H]	Material	Size [DxHmm]	Packing [Pcs / M <sup>2</sup> / KG]
CE2237E-64W2-RF2	175-240	64	65-75	≥80	0.5	/	AL+PMMA	600*400*120	1/0.050/2.5

# Ceiling Lights



90lm/w



CCT

DIM

RGB



- Easy Installation
- Back Glow
- 62mm Ultra-thin
- High Luminous Efficiency

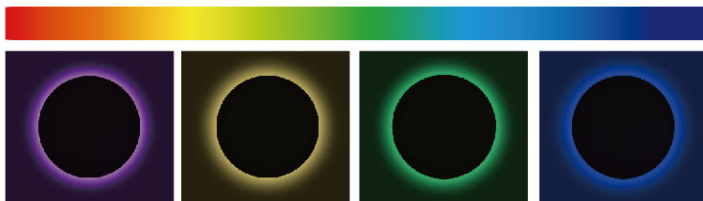

CE  ErP 2.0

Item No.	Voltage [V]	Wattage [W]	Lumen [lm]	Ra	PF	Life time [H]	Material	Size [DxHmm]	Packing [Pcs / M <sup>2</sup> / KG]
CE2003BC-24W2-IR3-G1	180-240	24	2160	80	>0.5	30000	PC	Ø280 * 62	10/0.056/12



# Ceiling Lights



- Built-in Tuya intelligent module
- WIFI remote control
- Have dimmable, CCT adjustable functions
- Support multi-scene choices, timing and RGB functions

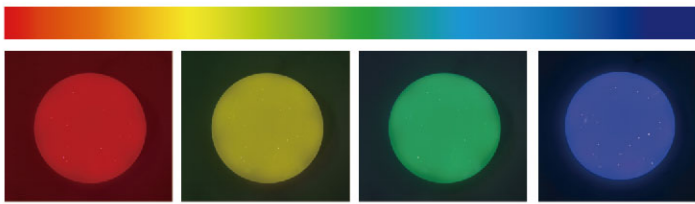

Item No.	Voltage [V]	Wattage [W]	Lumen [lm]	Ra	DF	Life time [H]	Material	Size [DxHmm]	Packing [Pcs / M <sup>3</sup> / KG]
CE1037-RGB	220	12	840	≥80	>0.7	25000	PMMA+IRON	Ø260 * 60	10/0.208/12
CE1037-RGB	220	18	1260	≥80	>0.7	25000	PMMA+IRON	Ø330 * 60	5/0.188/9.45
CE1037-RGB	220	24	1680	≥80	>0.7	25000	PMMA+IRON	Ø380 * 60	/
CE1037-RGB	220	36	2520	≥80	>0.7	25000	PMMA+IRON	Ø480 * 70	/

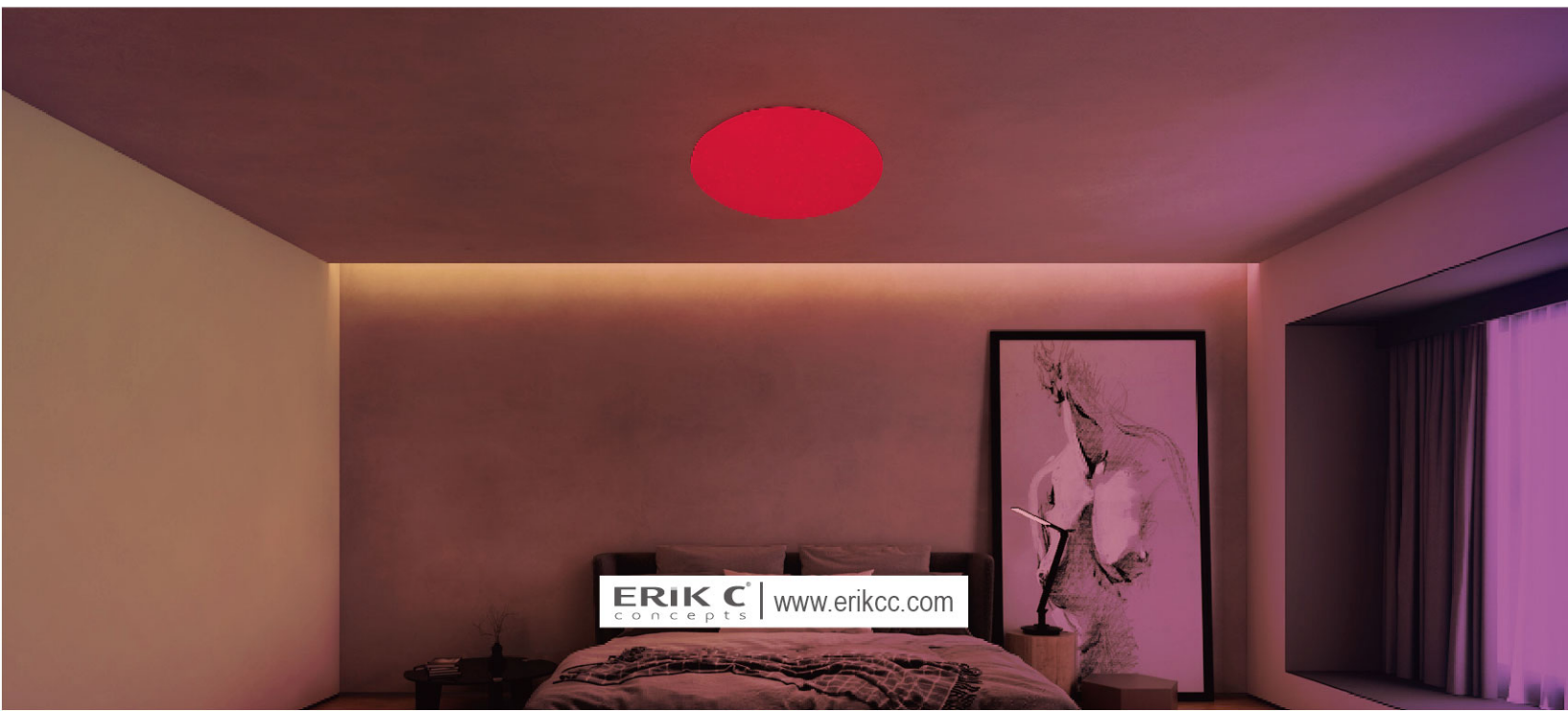

# Ceiling Lights

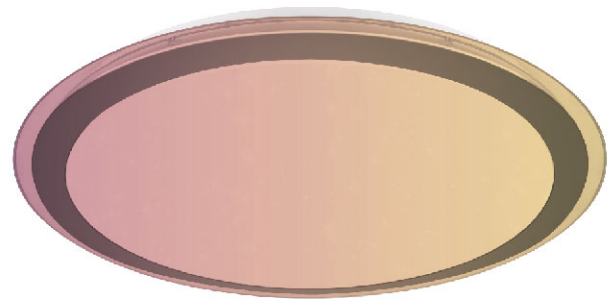

- Built-in Tuya intelligent module
- WIFI remote control
- Have dimmable, CCT adjustable functions
- Support multi-scene choices, timing and RGB functions

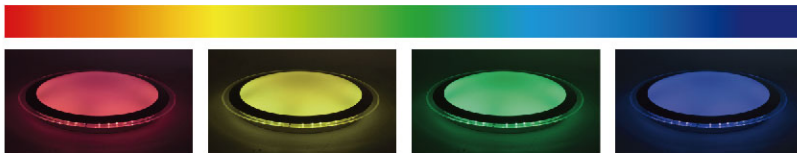

Item No.	Voltage [V]	Wattage [W]	Lumen [lm]	Ra	PF	Life time [H]	Material	Size [DxHmm]	Packing [Pcs / M <sup>3</sup> / KG]
CE2302-RGB	175-240	36	2340	80	0.5/0.9	25000	PMMA+IRON	Ø430 * 80	10/0.243/10.4
CE2302-RGB	175-240	60	3900	80	0.5/0.9	25000	PMMA+IRON	Ø525 * 80	5/0.165/9.1



# Ceiling Lights



- Music mode
- 2 years guarantee
- Have dimmable, CCT adjustable functions
- Support multi-scene choices, timing and RGB functions

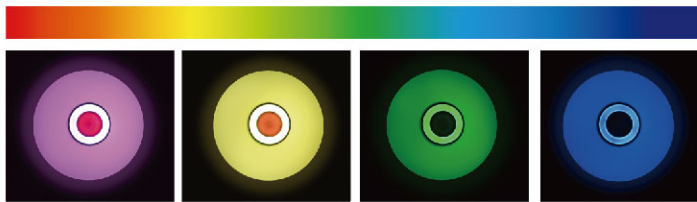

Item No.	Voltage [V]	Wattage [W]	Lumen [lm]	Ra	PF	Life time [H]	Material	Size [DxHmm]	Packing [Pcs / M <sup>3</sup> / KG]
CE1033	185-265	12	720	≥80	>0.9	25000	PMMA+IRON	Ø350 * 65	10/0.133/9
CE1033	185-265	24	1440	≥80	>0.9	25000	PMMA+IRON	Ø400 * 70	5/0.161/6
CE1033	185-265	30	1800	≥80	>0.9	25000	PMMA+IRON	Ø500 * 70	5/0.241/7



# Ceiling Lights



85lm/w

CCT

DIM

IP65



- Easy Installation
- 60mm Ultra-thin
- High Luminous Efficiency



Item No.	Voltage [V]	Wattage [W]	Lumen [lm]	Ra	PF	Life time [H]	Material	Size [DxHmm]	Packing [Pcs / M <sup>2</sup> / KG]
CE2179C-DP-G1	185-265	12	1020	80	>0.5	25000	PC+PC	Ø280 * 60	10/0.056/12
CE2179C-DP-G1	185-265	15	1275	80	>0.5	25000	PC+PC	Ø280 * 60	10/0.056/12
CE2179C-DP-G1	185-265	18	1530	80	>0.5	25000	PC+PC	Ø280 * 60	10/0.056/12
CE2179C-DP-G1	185-265	24	2040	80	>0.5	25000	PC+PC	Ø280 * 60	10/0.056/12



# Ceiling Lights



- 3 color temperature adjustable
- Dimming function



Item No.	Voltage [V]	Wattage [W]	Lumen [lm]	Ra	PF	Life time [H]	Material	Size [DxHmm]	Packing [Pcs / M <sup>3</sup> / KG]
CE2202	185-265	36	2340	≥80	>0.9	25000	PMMA+IRON	Ø400 * 80	10/0.216/10.5
CE2202	185-265	60	3900	≥80	>0.9	25000	PMMA+IRON	Ø500 * 80	5/0.154/8

# Ceiling Lights



- 3 color temperature adjustable
- Dimming function

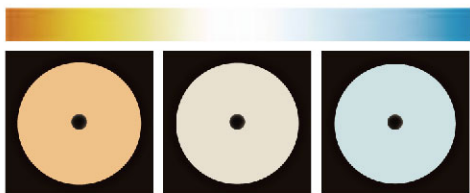

Item No.	Voltage [V]	Wattage [W]	Lumen [lm]	Ra	PF	Life time [H]	Material	Size [DxHmm]	Packing [Pcs / M <sup>3</sup> / KG]
CE2203	185-265	36	2340	≥80	>0.9	25000	PMMA+IRON	Ø500 * 70	10/0.216/10.5
CE2203	185-265	60	3900	≥80	>0.9	25000	PMMA+IRON	Ø720 * 75	5/0.154/8



# Ceiling Lights



- 3 color temperature adjustable
- Dimming function

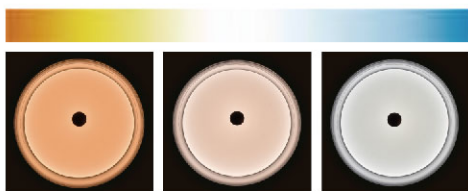
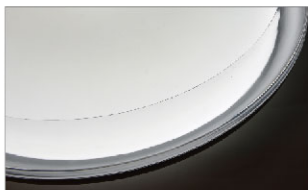

Item No.	Voltage [V]	Wattage [W]	Lumen [lm]	Ra	PF	Life time [H]	Material	Size [DxHmm]	Packing [Pcs / M <sup>3</sup> / KG]
CE2205	185-265	36	2340	≥80	>0.9	25000	PMMA+IRON	Ø400 * 80	10/0.216/10.5
CE2205	185-265	60	3900	≥80	>0.9	25000	PMMA+IRON	Ø500 * 80	5/0.154/8

# Ceiling Lights



- 3 color temperature adjustable
- Dimming function



CE1092



CE1092S

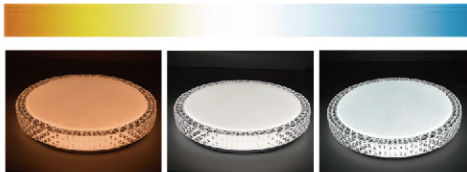

Item No.	Voltage [V]	Wattage [W]	Lumen [lm]	Ra	PF	Life time [H]	Material	Size [DxHmm]	Packing [Pcs / M <sup>2</sup> / KG]
CE1092	185-265	36	1980	≥80	>0.5	25000	PVC+IRON	Ø400 * 70	10/0.214/10
CE1092	185-265	60	3300	≥80	>0.5	25000	PVC+IRON	Ø490 * 110	5/0.178/9.5
CE1092S	185-265	36	1980	≥80	>0.5	25000	PVC+IRON	375 * 375 * 70	10/0.167/18
CE1092S	185-265	60	3300	≥80	>0.5	25000	PVC+IRON	475 * 475 * 110	5/0.167/13



# Ceiling Lights



- 3 color temperature adjustable
- Dimming function

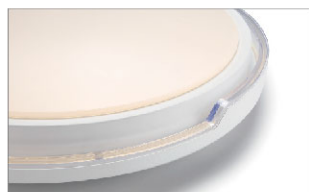

Item No.	Voltage [V]	Wattage [W]	Lumen [lm]	Ra	PF	Life time [H]	Material	Size [DxHmm]	Packing [Pcs / M <sup>3</sup> / KG]
CE2168	185-265	36	2340	≥80	0.5/0.9	25000	PMMA+IRON	Ø400 * 80	10/0.21/13
CE2168	185-265	60	3900	>80	0.5/0.9	25000	PMMA+IRON	Ø500 * 85	5/0.169/12

# Ceiling Lights



- 3 color temperature adjustable
- Dimming function



CE2302

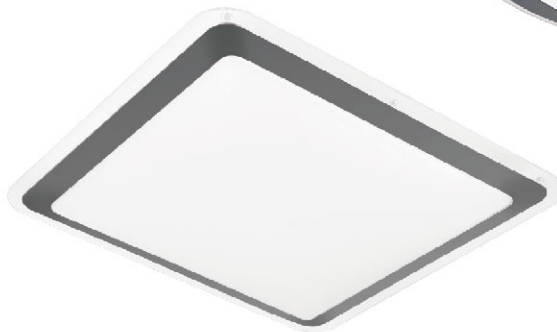

CE2301



Item No.	Voltage [V]	Wattage [W]	Lumen [lm]	Ra	PF	Life time [H]	Material	Size [DxHmm]	Packing [Pcs / M <sup>3</sup> / KG]
CE2301	185-265	24	1440	≥80	>0.5	25000	PMMA+IRON	∅400 * 70	10/0.130/13
CE2301	185-265	36	2160	≥80	>0.5	25000	PMMA+IRON	∅500 * 70	5/0.100/14
CE2302	185-265	36	2160	≥80	>0.5	25000	PMMA+IRON	335 * 335 * 70	10/0.130/10
CE2302	185-265	60	3600	≥80	>0.5	25000	PMMA+IRON	435 * 435 * 70	5/0.174/14



# Ceiling Lights

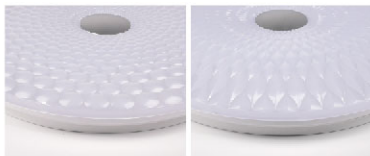

CE2313

CE2314



CE2315

CE2316

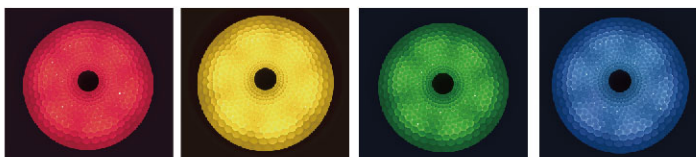

Item No.	Voltage [V]	Wattage [W]	Lumen [lm]	Ra	PF	Life time [H]	Material	Size [DxHmm]	Packing [Pcs / M <sup>2</sup> / KG]
CE2313/CE2314	185-265	36	2160	≥80	>0.5	25000	PMMA+IRON	Ø400 * 70	10/0.145/13
CE2313/CE2314	185-265	60	3600	≥80	>0.5	25000	PMMA+IRON	Ø500 * 70	5/0.112/14
CE2315/CE2316	185-265	36	2160	≥80	>0.5	25000	PMMA+IRON	Ø400 * 70	10/0.145/13
CE2315/CE2316	185-265	60	3600	≥80	>0.5	25000	PMMA+IRON	Ø500 * 70	5/0.112/14

# Ceiling Lights



CE1065

CE2033



CE2033



CE1065

11

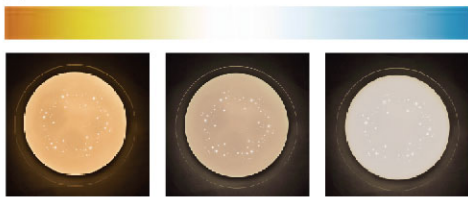

Item No.	Voltage [V]	Wattage [W]	Lumen [lm]	Ra	PF	Life time [H]	Material	Size [DxHmm]	Packing [Pcs / M <sup>3</sup> / KG]
CE1065	185-265	36	2340	>80	>0.9	25000	PMMA+IRON	Ø460*70	10/0.216/10.5
CE1065	185-265	60	3900	>80	>0.9	25000	PMMA+IRON	Ø560*75	5/0.154/8
CE2033	185-265	36	2340	≥80	>0.9	25000	PMMA+IRON	Ø470*90	10/0.11/11
CE2033	185-265	60	3900	≥80	>0.9	25000	PMMA+IRON	Ø560*100	5/0.179/10





# Ceiling Lights



CE2310



CE2311



CE2312

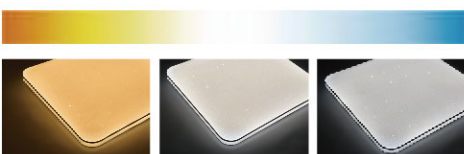

Item No.	Voltage [V]	Wattage [W]	Lumen [lm]	Ra	PF	Life time [H]	Material	Size [LxWxHmm]	Packing [Pcs / M <sup>2</sup> / KG]
CE2310	185-265V	36	2160	≥80	>0.5	25000	PMMA+IRON	430*430*70	10/0.166/11
CE2310	185-265V	60	3600	≥80	>0.5	25000	PMMA+IRON	530*530*70	10/0.244/16
CE2311	185-265V	36	2160	≥80	>0.5	25000	PMMA+IRON	430*430*70	10/0.166/11
CE2311	185-265V	60	3600	≥80	>0.5	25000	PMMA+IRON	530*530*70	10/0.244/16
CE2312	185-265V	36	2160	≥80	>0.5	25000	PMMA+IRON	430*430*70	10/0.166/11
CE2312	185-265V	60	3600	≥80	>0.5	25000	PMMA+IRON	530*530*70	10/0.244/16

# Ceiling Lights



- Built-in Tuya intelligent module
- WIFI remote control
- Have dimmable, CCT adjustable functions
- Support multi-scene choices and timing functions
- IP20

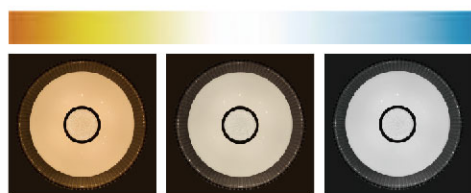

Item No.	Voltage [V]	Wattage [W]	Lumen [lm]	Ra	PF	Life time [H]	Material	Size [DxHmm]	Packing [Pcs / M <sup>3</sup> / KG]
CE2266	185-265	36	2160	≥80	>0.9	25000	PMMA+IRON	Ø430 * 70	10/0.209/14
CE2266	185-265	60	3600	≥80	>0.9	25000	PMMA+IRON	Ø530 * 70	5/0.286/14



# Ceiling Lights



- Built-in Tuya intelligent module
- WIFI remote control
- Have dimmable, CCT adjustable functions
- Support multi-scene choices and timing functions
- IP20

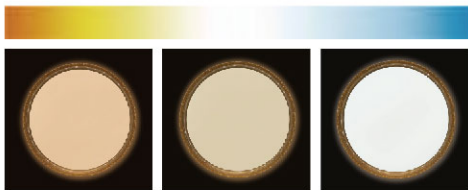

Item No.	Voltage [V]	Wattage [W]	Lumen [lm]	Ra	PF	Life time [H]	Material	Size [DxHmm]	Packing [Pcs / M <sup>2</sup> / KG]
CE2230	185-265	36	2160	≥80	>0.9	25000	PMMA+IRON	Ø400 * 70	10/0.209/14
CE2230	185-265	60	3600	≥80	>0.9	25000	PMMA+IRON	Ø500 * 70	5/0.285/16

# Ceiling Lights



- Built-in Tuya intelligent module
- WIFI remote control
- Have dimmable, CCT adjustable functions
- Support multi-scene choices and timing functions
- IP20

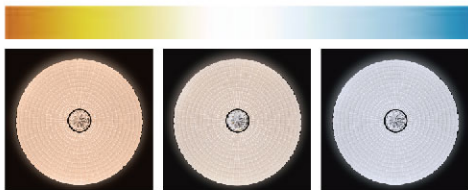

Item No.	Voltage [V]	Wattage [W]	Lumen [lm]	Ra	PF	Life time [H]	Material	Size [DxHmm]	Packing [Pcs / M <sup>3</sup> / KG]
CE2240	185-265	36	2160	≥80	>0.9	25000	PMMA+IRON	Ø400 * 70	10/0.209/14
CE2240	185-265	60	3600	≥80	>0.9	25000	PMMA+IRON	Ø500 * 70	5/0.286/16



# Ceiling Lights



- Built -in Tuya intelligent module
- WIFI remote control
- Have dimmable, CCT adjustable functions
- Support multi-scene choices and timing functions
- IP20

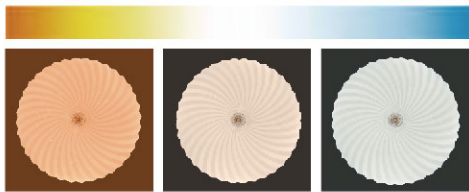

Item No.	Voltage [V]	Wattage [W]	Lumen [lm]	Ra	PF	Life time [H]	Material	Size [DxHmm]	Packing [Pcs / M <sup>3</sup> / KG]
CE2241	185-265	36	2160	≥80	>0.9	25000	PMMA+IRON	Ø400 * 70	10/0.209/14
CE2241	185-265	60	3600	≥80	>0.9	25000	PMMA+IRON	Ø500 * 70	5/0.286/16

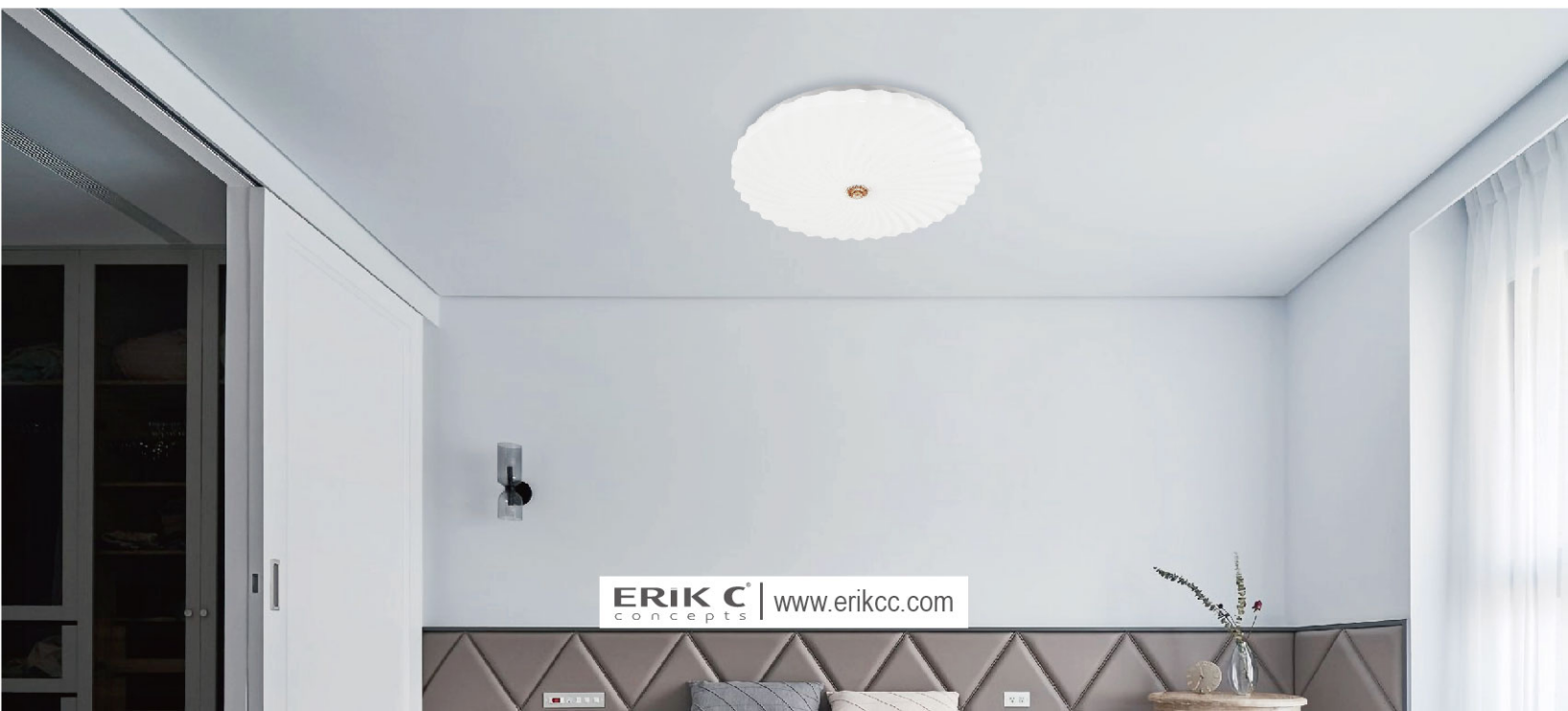

# Ceiling Lights



- Built-in Tuya intelligent module
- WIFI remote control
- Have dimmable, CCT adjustable functions
- Support multi-scene choices and timing functions
- IP20

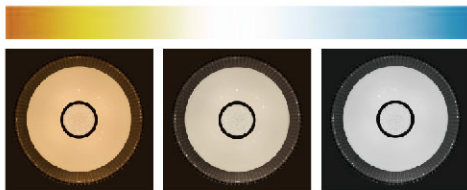

Item No.	Voltage [V]	Wattage [W]	Lumen [lm]	Ra	PF	Life time [H]	Material	Size [DxHmm]	Packing [Pcs / M <sup>3</sup> / KG]
CE2253	185-265	36	2160	≥80	>0.9	25000	PMMA+IRON	Ø400 * 70	10/0.209/14
CE2253	185-265	60	3600	≥80	>0.9	25000	PMMA+IRON	Ø500 * 70	5/0.286/16



# Ceiling Lights

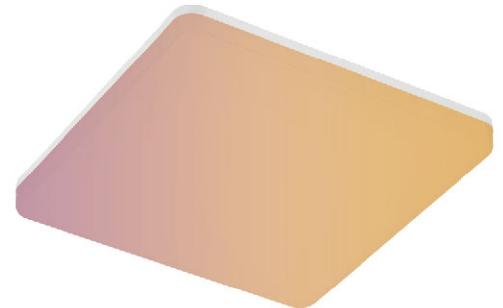

CE2004C



CE2003C



Item No.	Voltage [V]	Wattage [W]	Lumen [lm]	Ra	PF	Life time [H]	Material	Size [LxWxHmm]	Packing [Pcs / M <sup>2</sup> / KG]
CE2003C	220-240V	15	1350	≥80	>0.5	25000	PC+PC	Ø220*50	10/0.035/7.5
CE2003C	220-240V	18	1620	≥80	>0.5	25000	PC+PC	Ø280*50	10/0.055/8.5
CE2003C	220-240V	24	2160	≥80	>0.5	25000	PC+PC	Ø330*50	10/0.074/9.5
CE2003C	220-240V	36	3240	>80	>0.9	25000	PC+PC	Ø330*50	10/0.074/9.5
CE2004C	220-240V	15	1350	≥80	>0.5	25000	PC+PC	220*220*50	10/0.035/7.5
CE2004C	220-240V	18	1620	≥80	>0.5	25000	PC+PC	280*280*50	10/0.055/8.5
CE2004C	220-240V	24	2160	≥80	>0.5	25000	PC+PC	330*330*50	10/0.074/9.5
CE2004C	220-240V	36	3240	>80	>0.5	25000	PC+PC	330*330*50	10/0.074/9.5

# Ceiling Lights **NEW**

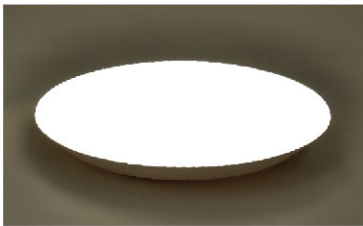

**CE ErP**

Item No.	Voltage [V]	Wattage [W]	Lumen [lm]	Ra	DF	Life time [H]	Material	Size [DxHmm]	Packing [Pcs / M <sup>2</sup> / KG]
CE2291C-12W2	185-265	12	840	80	0.7	/	PP+PP	Ø230 * 45	30/0.097//
CE2291C-18W2	185-265	18	1260	80	0.7	/	PP+PP	Ø280 * 50	20/0.099//
CE2291C-28W2	185-265	28	1960	80	0.7	/	PP+PP	Ø380 * 55	16/0.101//
CE2291C-45W2	185-265	45	3150	80	0.7	/	PP+PP	Ø480 * 60	10/0.103//

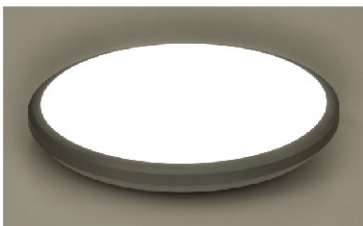

**CE ErP**

Item No.	Voltage [V]	Wattage [W]	Lumen [lm]	Ra	DF	Life time [H]	Material	Size [DxHmm]	Packing [Pcs / M <sup>2</sup> / KG]
CE4015C-12W2	185-265	12	960	80	0.7	/	PP+PP	Ø220 * 55	20/0.061//
CE4015C-20W2	185-265	20	1600	80	0.7	/	PP+PP	Ø270 * 55	20/0.090//
CE4015C-24W2	185-265	24	1920	80	0.7	/	PP+PP	Ø320 * 55	10/0.063//
CE4015C-36W2	185-265	36	2880	80	0.7	/	PP+PP	Ø380 * 55	10/0.088//



# Ceiling Lights



- Microwave sensing
- IP54 & IK08
- Easy installation



CE2166/ CE2166MS



CE2167/ CE2167MS

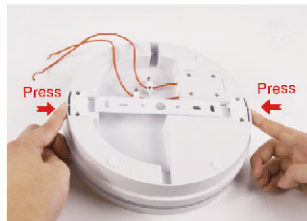
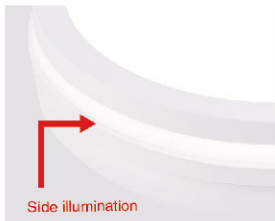
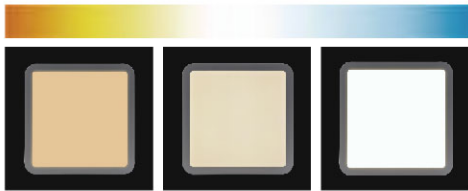

Item No.	Voltage [V]	Wattage [W]	Lumen [lm]	Ra	PF	Life time [H]	Material	Size [LxWxHmm]	Packing [Pcs / M <sup>2</sup> / KG]
CE2166	185-265V	18	1550	≥80	>0.5	25000	PP	Ø220*55	20/0.071/10.3
CE2166MS	185-265V	18	1550	≥80	>0.5	25000	PP	Ø220*55	20/0.071/10.3
CE2167	185-265V	18	1550	≥80	>0.5	25000	PP	220*220*55	20/0.071/10.5
CE2167MS	185-265V	18	1550	≥80	>0.5	25000	PP	220*220*55	20/0.071/10.5



# Ceiling Lights



- Multi-scene selection
- Smart control

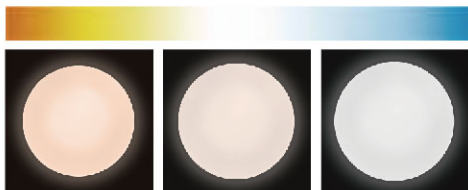

Item No.	Voltage [V]	Wattage [W]	Lumen [lm]	Ra	PF	Life time [H]	Material	Size [DxHmm]	Packing [Pcs / M <sup>3</sup> / KG]
Smart-CE2017	185-265	12	840	≥80	>0.9	25000	PMMA+IRON	Ø260 * 60	20/0.013/10
Smart-CE2017	185-265	18	1260	≥80	>0.9	25000	PMMA+IRON	Ø330 * 65	20/0.022/12
Smart-CE2017	185-265	24	1680	≥80	>0.9	25000	PMMA+IRON	Ø380 * 65	20/0.032/14
Smart-CE2017	185-265	36	2500	≥80	>0.9	25000	PMMA+IRON	Ø380 * 65	/
Smart-CE2017	185-265	48	3100	≥80	>0.9	25000	PMMA+IRON	Ø480 * 75	/
Smart-CE2017	185-265	60	3900	≥80	>0.9	25000	PMMA+IRON	Ø600 * 100	/
Smart-CE2017	185-265	80	4800	≥80	>0.9	25000	PMMA+IRON	Ø700 * 120	/
Smart-CE2017	185-265	100	6000	≥80	>0.9	25000	PMMA+IRON	Ø800 * 140	/



# Ceiling Lights



- Built-in Tuya intelligent module
- WIFI remote control
- Have dimmable, CCT adjustable functions
- Support multi-scene choices and timing function

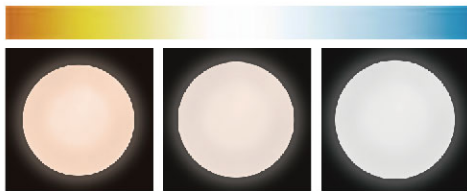

Item No.	Voltage [V]	Wattage [W]	Lumen [lm]	Ra	PF	Life time [H]	Material	Size [DxHmm]	Packing [Pcs / M <sup>2</sup> / KG]
Smart-CE3030-WF2	185-265	18	1620	>80	>0.5	25000	PC+PC	Ø280 * 60	10/0.063/9
Smart-CE3030-WF2	185-265	24	2160	≥80	>0.5	25000	PC+PC	Ø280 * 60	10/0.063/9
Smart-CE3030-WF2	185-265	30	2700	≥80	>0.9	25000	PC+PC	Ø330 * 60	8/0.070/9.2
Smart-CE3030-WF2	185-265	36	3240	≥80	>0.9	25000	PC+PC	Ø330 * 60	8/0.070/9.2



# Ceiling Lights



CE2247-2



CE2247-3

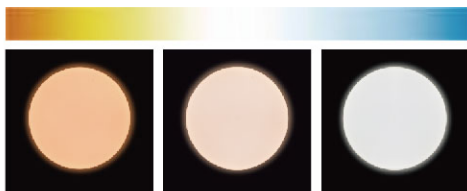

Item No.	Voltage [V]	Wattage [W]	Lumen [lm]	Ra	PF	Life time [H]	Material	Size [DxHmm]	Packing [Pcs / M <sup>3</sup> / KG]
CE2247-2-12W	185-265	12	1068	>80	>0.5	25000	PVC+PP	Ø265 * 70	12/0.096/7.2
CE2247-2-18W	185-265	18	1547	>80	>0.5	25000	PVC+PP	Ø328 * 84	10/0.114/7.7
CE2247-2-24W	185-265	24	2400	≥80	>0.5	25000	PVC+PP	Ø374 * 87	10/0.156/9.3
CE2247-3-12W	185-265	12	1100	>80	>0.5	25000	PVC+PP	Ø240 * 79	5/0.032/2.3
CE2247-3-18W	185-265	18	1800	≥80	>0.5	25000	PVC+PP	Ø300 * 83	5/0.051/3.3
CE2247-3-24W	185-265	24	2200	≥80	>0.5	25000	PVC+PP	Ø345 * 85	5/0.067/4.1

# Ceiling Lights



- 3 Color temperature adjustable
- Super-slim profile 50mm

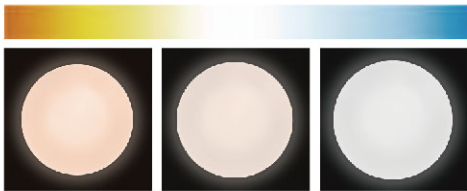

Item No.	Voltage [V]	Wattage [W]	Lumen [lm]	Ra	PF	Life time [H]	Material	Size [DxHmm]	Packing [Pcs / M <sup>2</sup> / KG]
CE2175/CE2175	185-265	12	1080	80	0.5	25000	PC+PC	Ø250 * 50	10/0.051/8
CE2175/CE2175	185-265	24	2160	80	0.5	25000	PC+PC	Ø320 * 50	10/0.072/9
CE2175/CE2175	185-265	40	3600	80	0.5/0.9	25000	PC+PC	Ø380 * 50	10/0.112/11



- 3 Color temperature adjustable
- Super-slim profile 30mm

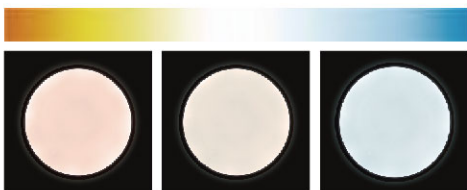

Item No.	Voltage [V]	Wattage [W]	Lumen [lm]	Ra	PF	Life time [H]	Material	Size [DxHmm]	Packing [Pcs / M <sup>2</sup> / KG]
CE2176/CE2176	175-240	18	1620	80	0.5	25 000	PC+PC	Ø300 * 30	10/0.051/8
CE2176/CE2176	175-240	24	2160	80	0.5	25 000	PC+PC	Ø420 * 30	10/0.097/9



# Ceiling Lights



Light source can be replaced

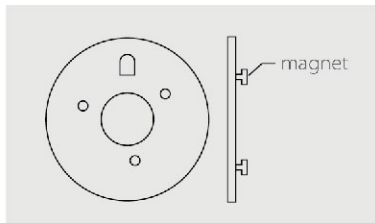

- Light source can be replaced
- Customized design
- CCT Adjustable by Dial Switch
- IP20

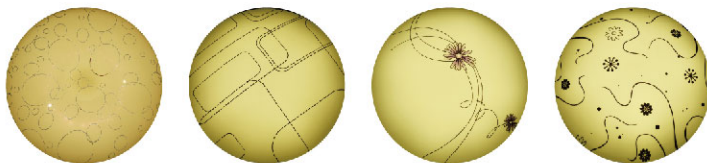

Item No.	Voltage [V]	Wattage [W]	Lumen [lm]	Ra	PF	Life time [H]	Material	Size [DxHmm]	Packing [Pcs / M <sup>2</sup> / KG]
CE1003	185-265	12	840	≥80	>0.5	25000	PMMA+IRON	Ø260 * 90	16/0.139/8
CE1003	185-265	18	1170	≥80	>0.5	25000	PMMA+IRON	Ø330 * 95	10/0.138/7
CE1003	185-265	24	1560	≥80	>0.5	25000	PMMA+IRON	Ø380 * 100	10/0.203/10
CE1003	185-265	36	2360	≥80	>0.5	25000	PMMA+IRON	Ø480 * 105	5/0.286/16

# Ceiling Lights



**IP20/IP44**



CE1003IS

CE1003MS

CE1003E

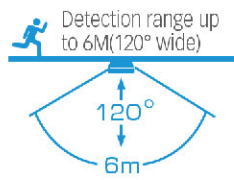

**Induction description**

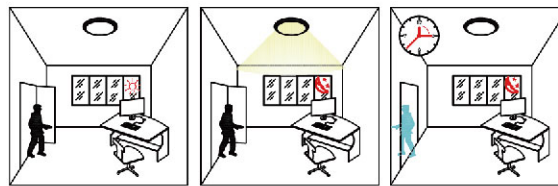

Day    Light-out    Night    Light-on    light-out

**Emergency**

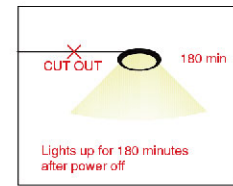

Item No.	Voltage [V]	Wattage [W]	Lumen [lm]	Ra	PF	Life time [H]	Material	Size [DxHmm]	Packing [Pcs / M <sup>2</sup> / KG]
CE1003IS	185-265	12	780	≥80	>0.5	25000	PMMA+Iron	Ø260*90	20/0.145/12
CE1003IS	185-265	18	1170	≥80	>0.5	25000	PMMA+Iron	Ø330*100	10/0.141/8
CE1003IS	185-265	24	1560	≥80	>0.5	25000	PMMA+Iron	Ø380*110	10/0.192/9
CE1003MS	185-265	12	780	≥80	>0.5	25000	PMMA+Iron	Ø260*90	20/0.145/12
CE1003MS	185-265	18	1170	≥80	>0.5	25000	PMMA+Iron	Ø330*100	10/0.141/8
CE1003MS	185-265	24	1560	≥80	>0.5	25000	PMMA+Iron	Ø380*110	10/0.192/9
CE1003E	185-265	12	780	≥80	>0.5	25000	PMMA+Iron	Ø260*90	20/0.145/12
CE1003E	185-265	18	1170	≥80	>0.5	25000	PMMA+Iron	Ø330*100	10/0.141/8
CE1003E	185-265	24	1560	≥80	>0.5	25000	PMMA+Iron	Ø380*110	10/0.192/9

# Ceiling Lights



Light source can be replaced

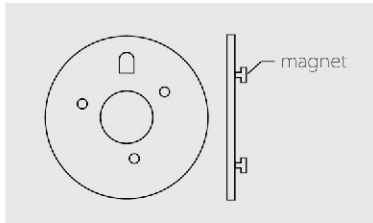

- Light source can be replaced
- Customized design



Item No.	Voltage [V]	Wattage [W]	Lumen [lm]	Ra	PF	Life time [H]	Material	Size [DxHmm]	Packing [Pcs / M <sup>2</sup> / KG]
CE2017	185-265	12	720	≥80	>0.5	25000	PMMA+Iron	Ø258*50	20/0.013/10
CE2017	185-265	18	1080	≥80	>0.5	25000	PMMA+Iron	Ø330*55	20/0.022/12
CE2017	185-265	24	1440	≥80	>0.5	25000	PMMA+Iron	Ø380*55	20/0.032/14





**Design Down Lights**

# Design Down Lights



- Built-in Tuya intelligent module
- WIFI remote control
- Have dimmable, CCT adjustable functions
- Support multi-scene choices and timing functions



## Removable

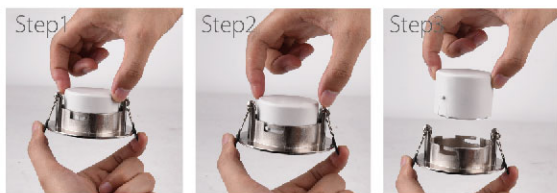

## Color options



Brown antique brass

Red antique brass

Black scrub

Titan

Gold

Silver

White

Chrome

## Dimmable (Optional)



Dimming function optional



Item No.	Voltage [V]	Wattage [W]	Lumen [lm]	Ra	Life Time [H]	Ceiling Hole [mm]	Size [mm]
Smart-DL1101C-05W3-A7	100-240	5	400	80	25000	Ø75-80	Ø84*40
DL1101	100-240	5	400	80	25000	Ø75-80	Ø84*40
DL1101	100-240	7	560	80	25000	Ø75-80	Ø84*40



# Design Down Lights

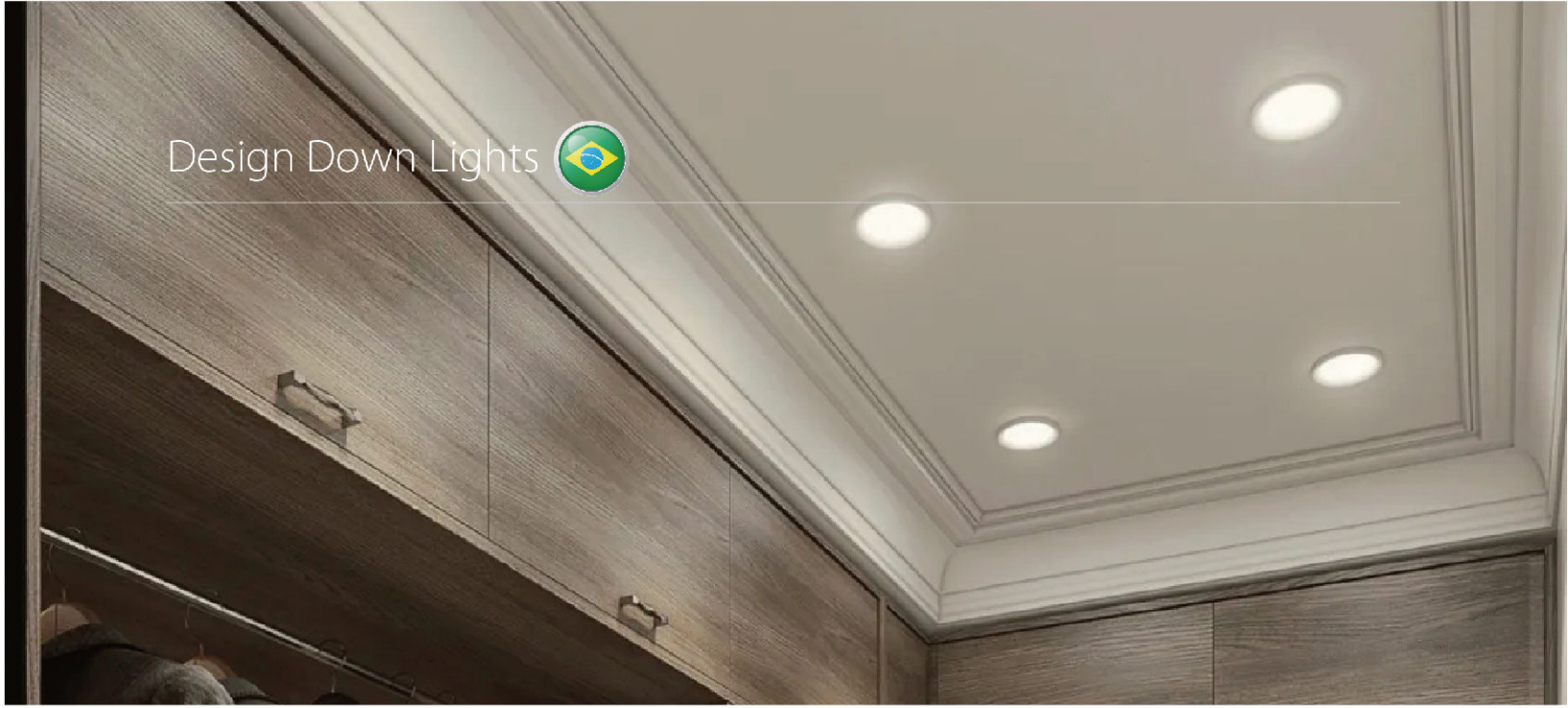

## Application

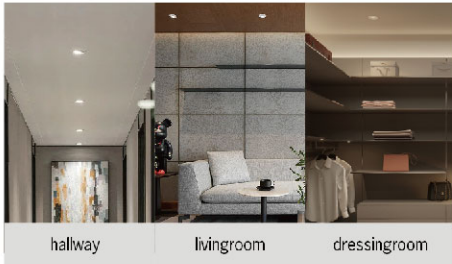

hallway

livingroom

dressingroom

Ideal for multiple scenarios

## Adjustable angle



38° vertical rotation



38°



Item No.	Wattage [W]	Lumen [lm]	Material	Color	Ceiling Hole [mm]	Size [mm]
DL1105-1	3	210	PET	White	55-60	70
DL1105-2	5	350	PET	White	70-75	90
DL1105-3	7	490	PET	White	70-75	90
DL1105-4	9	630	PET	White	90-95	117
DL1105-5	12	840	PET	White	110-115	117



38°

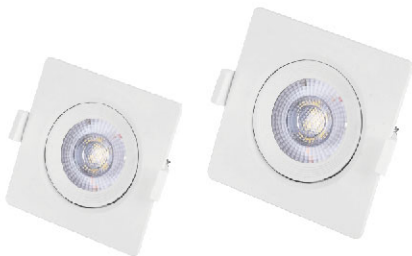

Item No.	Wattage [W]	Lumen [lm]	Material	Color	Ceiling Hole [mm]	Size [mm]
DL1106-1	3	210	PET	White	55-60	70
DL1106-2	5	350	PET	White	70-75	90
DL1106-3	7	490	PET	White	70-75	90
DL1106-4	9	630	PET	White	90-95	120
DL1106-5	12	840	PET	White	110-115	140



# Design Down Lights



## Application

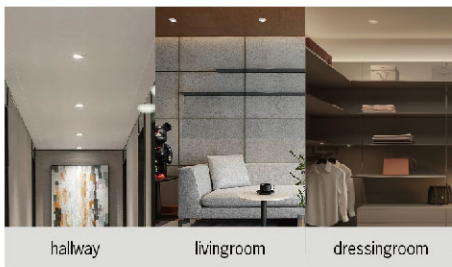

hallway

livingroom

dressingroom

Ideal for multiple scenarios

## Color options

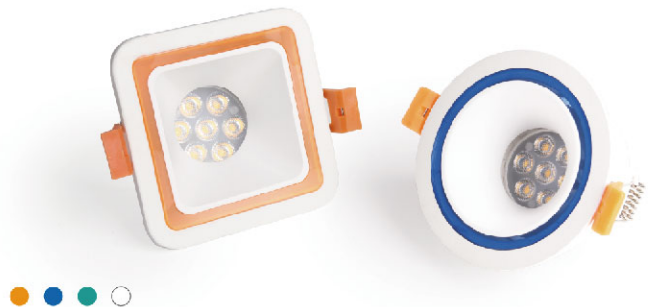

Item No.	Base	Material	Color	Ceiling Hole [mm]	Size [mm]
DL2713	GU10	Alu.	White	D75	D88*40
DL2714	GU10	Alu.	White	D90	D102*48
DL2715	GU10	Alu.	White	D70	D88*52

Item No.	Base	Material	Color	Ceiling Hole [mm]	Size [mm]
DL2716	GU10	Alu.	White	D75	88*88*90
DL2717	GU10	Alu.	White	D90	103*103*42

Item No.	Base	Material	Color	Ceiling Hole [mm]	Size [mm]
DL2718	GU10	Alu.	White	D90	88*88*50

# Design Down Lights

**IP20**



**DL2002**

- Ø 84\* 25mm    75mm
- MR16,12V    Zinc
- Max.50W    Zinc alloy

**IP20**



**DL2277**

- Ø 84\* 25mm    75mm
- MR16,12V    Zinc
- Max.50W    Zinc alloy

**IP20**



**DL6103**

- Ø 109\* 55mm    80mm
- MR16,12V    Iron
- Max.50W

**IP44**



**DL2235**

- Ø 84\* 25mm    75mm
- MR16,12V    Alu.
- Max.50W

**IP44**



**DL2235**

- Ø 84\* 25mm    75mm
- MR16,12V    Alu.
- Max.50W

**IP44**



**DL2236**

- Ø 92\* 33mm    70mm
- MR16,12V    Iron
- Max.50W

## Application

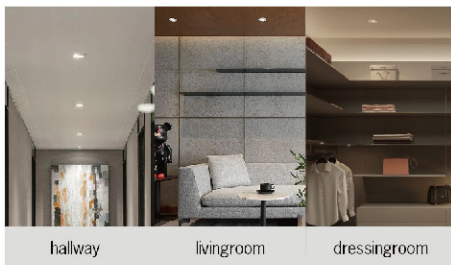

hallway    livingroom    dressingroom

Ideal for multiple scenarios

## Color option



White    Black    Gold    Chrome    Titan    Green Antique Brass    Red Antique Brass

# Design Down Lights



**DL3224**  
 Ø 120\*25mm  
 MR16/MAX50W,  
 Belt side luminous 5W  
 Material Alu + crystal beads



**DL3216**  
 Ø 120\*25mm  
 MR16/MAX50W,  
 Belt side luminous 5W  
 Material Alu + crystal beads



**DL3226**  
 Ø 120\*25mm  
 MR16/MAX50W,  
 Belt side luminous 5W  
 Material Alu + crystal beads



**DL3182**  
 Ø 120\*25mm  
 LED/5W, Belt side luminous 5W  
 Material Alu + crystal beads



**DL3222**  
 Ø 120\*25mm  
 MR16/MAX50W,  
 Belt side luminous 5W  
 Material Alu + crystal beads



**DL3225**  
 Ø 120\*25mm  
 MR16/MAX50W,  
 Belt side luminous 5W  
 Material Alu + crystal beads



**DL5506-MR16**  
 Ø 100\*25mm  
 MR16/G5.3, Side light/3W  
 Material Alu. +Resin+chrome



**DL5504**  
 Ø 100\*25mm  
 MR16/G5.3, Side light/3W  
 Material Alu. +Resin+chrome



**DL5503**  
 Ø 100\*25mm  
 MR16/G5.3, Side light/3W  
 Material Alu. +Resin+chrome



# Design Down Lights



**DL3400-1**  
 Ø 95mm ✎ 60mm  
 MR16, 220V/50Hz  
 SDM2835  
 Material Resin+Alu.



**DL3400-2**  
 Ø 95mm ✎ 60mm  
 MR16, 220V/50Hz  
 SDM2835  
 Material Resin+Alu.



**DL3400-3**  
 Ø 95mm ✎ 60mm  
 MR16, 220V/50Hz  
 SDM2835  
 Material Resin+Alu.



**DL3401-1**  
 Ø 100mm ✎ 60mm  
 MR16, 220V/50Hz  
 SDM2835  
 Material Resin+Alu.



**DL3401-2**  
 Ø 100mm ✎ 60mm  
 MR16, 220V/50Hz  
 SDM2835  
 Material Resin+Alu.



**DL3401-3**  
 Ø 100mm ✎ 60mm  
 MR16, 220V/50Hz  
 SDM2835  
 Material Resin+Alu.



**DL3402-1**  
 Ø 95mm ✎ 60mm  
 MR16, 220V/50Hz  
 SDM2835  
 Material Resin+Alu.



**DL3402-2**  
 Ø 95mm ✎ 60mm  
 MR16, 220V/50Hz  
 SDM2835  
 Material Resin+Alu.



**DL3402-3**  
 Ø 95mm ✎ 60mm  
 MR16, 220V/50Hz  
 SDM2835  
 Material Resin+Alu.



**DL3402-4**  
 Ø 95mm ✎ 60mm  
 MR16, 220V/50Hz  
 SDM2835  
 Material Resin+Alu.



**DL3402-5**  
 Ø 95mm ✎ 60mm  
 MR16, 220V/50Hz  
 SDM2835  
 Material Resin+Alu.



**DL3402-6**  
 Ø 95mm ✎ 60mm  
 MR16, 220V/50Hz  
 SDM2835  
 Material Resin+Alu.

# Design Down Lights



**DL3403-1**  
 Ø 115mm ✎ 60mm  
 MR16, 220V/50Hz  
 SDM2835  
 Resin+Alu.  
 Black • White



**DL3403-2**  
 Ø 115mm ✎ 60mm  
 MR16, 220V/50Hz  
 SDM2835  
 Resin+Alu.  
 Black • White



**DL3403-3**  
 Ø 115mm ✎ 60mm  
 MR16, 220V/50Hz  
 SDM2835  
 Resin+Alu.  
 Black • White



**DL3403-4**  
 Ø 115mm ✎ 60mm  
 MR16, 220V/50Hz  
 SDM2835  
 Resin+Alu.  
 Black • White



**DL3403-5**  
 Ø 115mm ✎ 60mm  
 MR16, 220V/50Hz  
 SDM2835  
 Resin+Alu.  
 Black • White



**DL3403-6**  
 Ø 115mm ✎ 60mm  
 MR16, 220V/50Hz  
 SDM2835  
 Resin+Alu.  
 Black • White



**DL3403-7**  
 Ø 115mm ✎ 60mm  
 MR16, 220V/50Hz  
 SDM2835  
 Resin+Alu.  
 Black • White



**DL3403-8**  
 Ø 115mm ✎ 60mm  
 MR16, 220V/50Hz  
 SDM2835  
 Resin+Alu.  
 Black • White



**DL3403-9**  
 Ø 115mm ✎ 60mm  
 MR16, 220V/50Hz  
 SDM2835  
 Resin+Alu.  
 Black • White



**DL3403-10**  
 Ø 115mm ✎ 60mm  
 MR16, 220V/50Hz  
 SDM2835  
 Resin+Alu.  
 Black • White



**DL3403-11**  
 Ø 115mm ✎ 60mm  
 MR16, 220V/50Hz  
 SDM2835  
 Resin+Alu.  
 Black • White



**DL3403-12**  
 Ø 115mm ✎ 60mm  
 MR16, 220V/50Hz  
 SDM2835  
 Resin+Alu.  
 Black • White



# Wall Lamps & Spot Lamps





# Wall Lamps & Spot Lamps **NEW**



Item No.	Material	Voltage [V]	Wattage [W]
ML3001-4	ABS+PC lens	165-265	4*1
ML3001-6	ABS+PC lens	165-265	6*1
ML3001-8	ABS+PC lens	165-265	8*1

# Wall Lamps & Spot Lamps **NEW**



Item No.	Material	Voltage [V]	Wattage [W]
ML3004	ABS+PC lens	165-265	2*3 COB



# Wall Lamps & Spot Lamps **NEW**

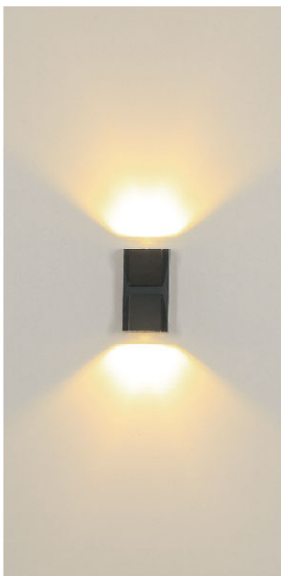





Item No.	Material	Voltage [V]	Wattage [W]
ML3005	ABS+PC lens	165-265	2*3 COB

# Wall Lamps & Spot Lamps **NEW**



Item No.	Material	Voltage [V]	Wattage [W]
ML3007	ABS+PC lens	165-265	6



# Wall Lamps & Spot Lamps **NEW**

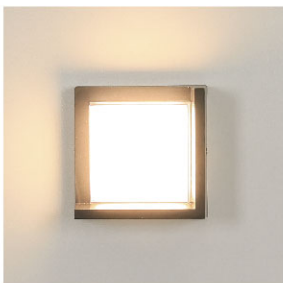

Item No.	Material	Voltage (V)	Wattage (W)
ML3013-6W	ABS+PC lens	165-265	6
ML3013-3W	ABS+PC lens	165-265	3

# Wall Lamps & Spot Lamps **NEW**

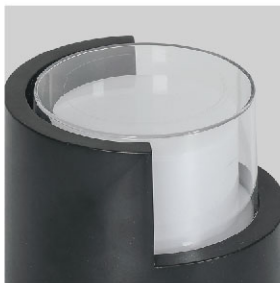
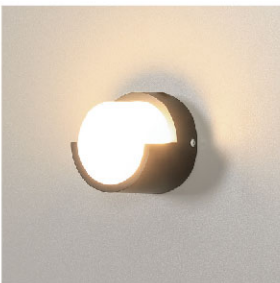

Item No.	Material	Voltage (V)	Wattage (W)
ML3014-6W	ABS+PC lens	165-265	6
ML3014-3W	ABS+PC lens	165-265	3



# Wall Lamps & Spot Lamps **NEW**



Item No.	Material	Voltage [V]	Wattage [W]
ML3017	ABS+PC lens	165-265	2*3 COB

# Wall Lamps & Spot Lamps **NEW**

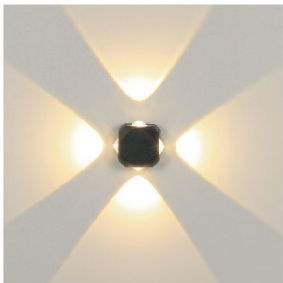

Item No.	Material	Voltage [V]	Wattage [W]
ML3018	ABS+PC lens	165-265	4*1



# Wall Lamps & Spot Lamps **NEW**

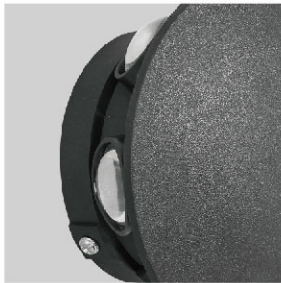
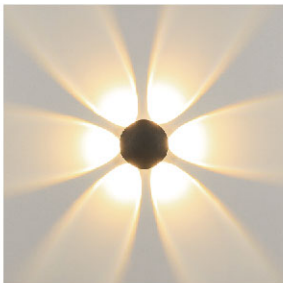

Item No.	Material	Voltage [V]	Wattage [W]
ML3020	ABS+PC lens	165-265	6*1



# Wall Lamps & Spot Lamps **NEW**

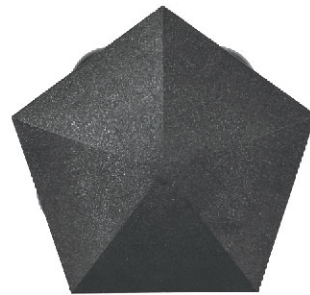





Item No.	Material	Voltage [V]	Wattage [W]
ML3022	ABS+PC lens	165-265	5*1

# Wall Lamps & Spot Lamps **NEW**

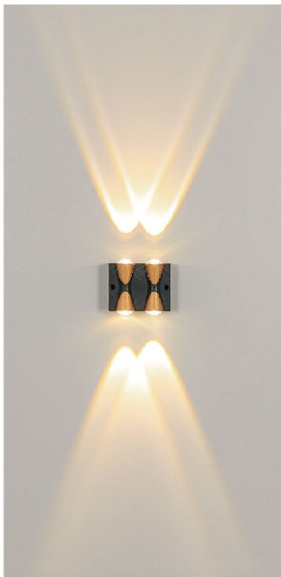

Item No.	Material	Voltage [V]	Wattage [W]
ML3023-4	ABS+PC lens	165-265	4*1
ML3023-6	ABS+PC lens	165-265	6*1
ML3023-8	ABS+PC lens	165-265	8*1



# Wall Lamps & Spot Lamps **NEW**

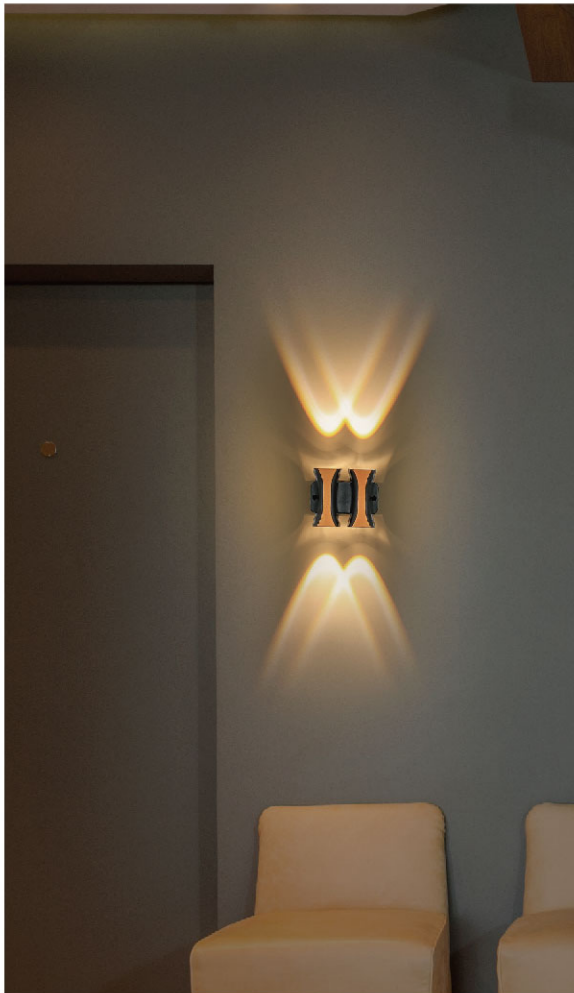





Item No.	Material	Voltage [V]	Wattage [W]
ML3026-4	ABS+PC lens	165-265	4*1
ML3026-6	ABS+PC lens	165-265	6*1
ML3026-8	ABS+PC lens	165-265	8*1

# Wall Lamps & Spot Lamps

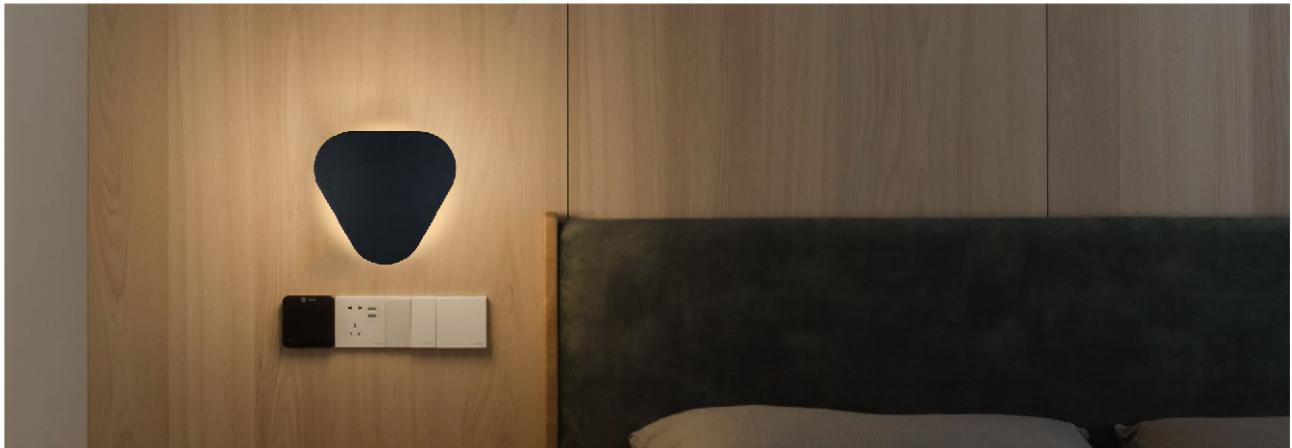

### Feature

It can be used in bedrooms, bathrooms, etc.  
IP20 Waterproof



**IP20** **50±10% lm/W** **Ra 80**

### Color options

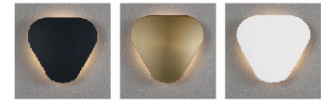

Black Golden White

Item No.	Wattage [W]	Chip	Material	PF	Size [mm]
DL6601	6	Epistar.SMD 2835	Die-Casting aluminum+ PC	0.5	170*160* 31
DL6601	12	Epistar.SMD 2835	Die-Casting aluminum+ PC	0.9	225* 210* 45
DL6601	24	Epistar.SMD 2835	Die-Casting aluminum+ PC	0.9	280* 265* 53

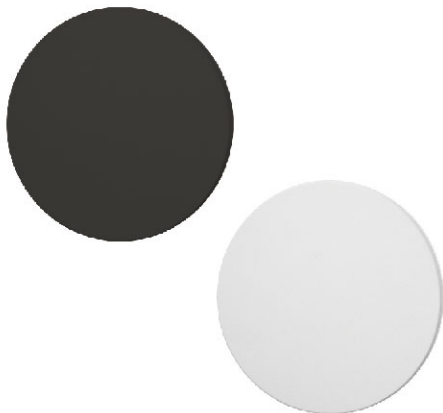

### Feature

It can be used in bedrooms, bathrooms, etc.  
IP20 Waterproof



**IP20** **50±10% lm/W** **Ra 80**

### Color options

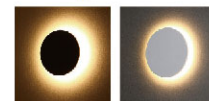

Black White

Item No.	Wattage [W]	Chip	Material	PF	Size [mm]
DL6602	6	Epistar.SMD 2835	Aluminum+PC	0.5	Ø135* 31
DL6602	12	Epistar.SMD 2835	Aluminum+PC	0.9	Ø180* 45
DL6602	24	Epistar.SMD 2835	Aluminum+PC	0.9	Ø230* 53



# Wall Lamps & Spot Lamps



## High power

- It can be used in bedrooms, bathrooms, etc.
- IP20 Waterproof
- It is the good assistant that reads a book in the evening.

## Color options



Black Golden White

## Product options

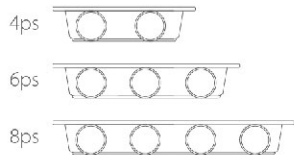

Item No.	Chip	Material	Wattage [W]	PF	Ra	Size [mm]
DL6603	High power	Die-casting aluminum+PC	4	0.5	80	130* 80* 40
DL6603	High power	Die-casting aluminum+PC	6	0.5	80	180* 90* 40
DL6603	High power	Die-casting aluminum+PC	8	0.5	80	230* 100* 40

# Wall Lamps & Spot Lamps



### Product details



Item No.	Wattage [W]	Chip	Material	PF	Size [mm]
DL6604	3+6	CREE XBD+Epistar SMD 5730	Aluminum+PC	0.5	240* 130* 80



### Feature

It can be used in bedrooms, bathrooms, etc.  
IP20 Waterproof  
The two switches are controlled separately.



Item No.	Wattage [W]	Chip	Material	PF	Size [mm]
DL6605	3+6	CREE XBD+Epistar SMD 5730	Aluminum+PC	0.5	106* 152* 100



Item No.	Wattage [W]	Chip	Material	PF	Size [mm]
DL8212	3+6	CREE XPE+Epistar SMD 5730	Aluminum+PC	0.5	130* 130* 50



# Wall Lamps & Spot Lamps

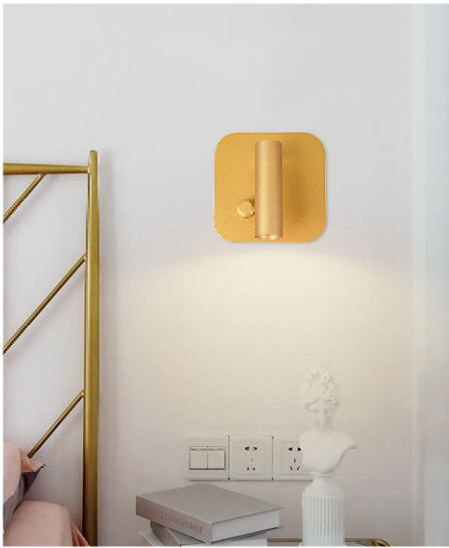

## Product details



Item No.	Wattage [W]	Chip	Material	PF	Size [mm]
DL6607	3	CREE XPE	Aluminum+PC	0.5	140*140*75



## Feature

It can be used in bedrooms, bathrooms, etc.  
IP20 Waterproof



Item No.	Wattage [W]	Chip	Material	PF	Size [mm]
DL6608	3+6	CREE XBD+Epistar SMD 5730	Aluminum+PC	0.5	125*130*50



## Color options



Black White



Item No.	Wattage [W]	Chip	Material	PF	Size [mm]
DL6609	3+6	CREE XBD+Epistar SMD 5730	Aluminum+PC	0.5	120*200*48

# Wall Lamps & Spot Lamps



### Color options



Black

White



IP20



50±10% lm/W



Ra 80

Item No.	Wattage [W]	Chip	Material	PF	Size [mm]
DL6610	3+3	CREE XBD+Epistar SMD 5730	Aluminum+PC	0.5	150* 140* 114

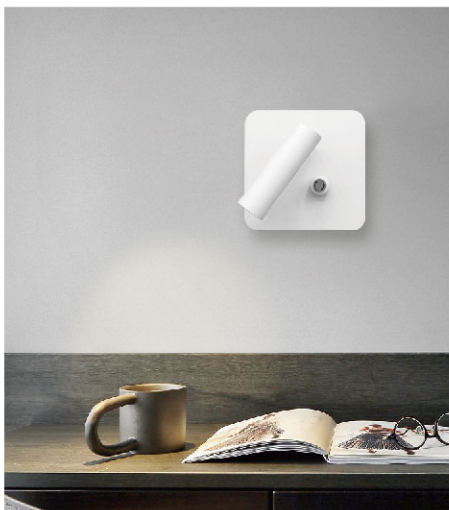

### Feature

It can be used in bedrooms, bathrooms, etc.  
IP20 Waterproof



IP20



50±10% lm/W



Ra 80

Item No.	Wattage [W]	Chip	Material	PF	Size [mm]
DL6611	3+6	CREE XBD+Epistar SMD 5730	Aluminum+PC	0.5	130* 130* 75



### Product details



IP20



50±10% lm/W



Ra 80

Item No.	Wattage [W]	Chip	Material	PF	Size [mm]
DL6612	3+8	CREE XTE+Epistar SMD 2835	Aluminum+PC	0.5	300* 120* 30

# Wall Lamps & Spot Lamps



TS1011-1



TS1011-3



TS1011-4



TS1011-2



TS1011-3G



TS1011-6

Code	TS1011-1	TS1011-2	TS1011-3	TS1011-3G	TS1011-4	TS1011-6
Watt	1*5W	2*5W	3*5W	3*5W	4*5W	6*5W
Lumens	1*330lm	2*330lm	3*330lm	3*330lm	4*330lm	6*330lm
L x D x H	116*Ø100*185	310*Ø100*230	490*Ø100*230	250*Ø100*230	790*Ø100*230	1800*Ø130*250



# Wall Lamps & Spot Lamps



SMD3528



ALUMINUM+IRON+PC



TS1010-1



TS1010-2



TS1010-4



TS1010-3



TS1010-3G



TS1010-6

Code	TS1010-1	TS1010-2	TS1010-3	TS1010-3G	TS1010-4	TS1010-6
Watt	1*4W	2*4W	3*4W	3*4W	4*4W	6*4W
Lumens	1*330lm	2*330lm	3*330lm	3*330lm	4*330lm	6*330lm
LxDxH	80*Ø80*130	300*Ø80*140	480*Ø80*140	250*Ø80*140	580*Ø80*140	1800*Ø80*185

# Wall Lamps & Spot Lamps

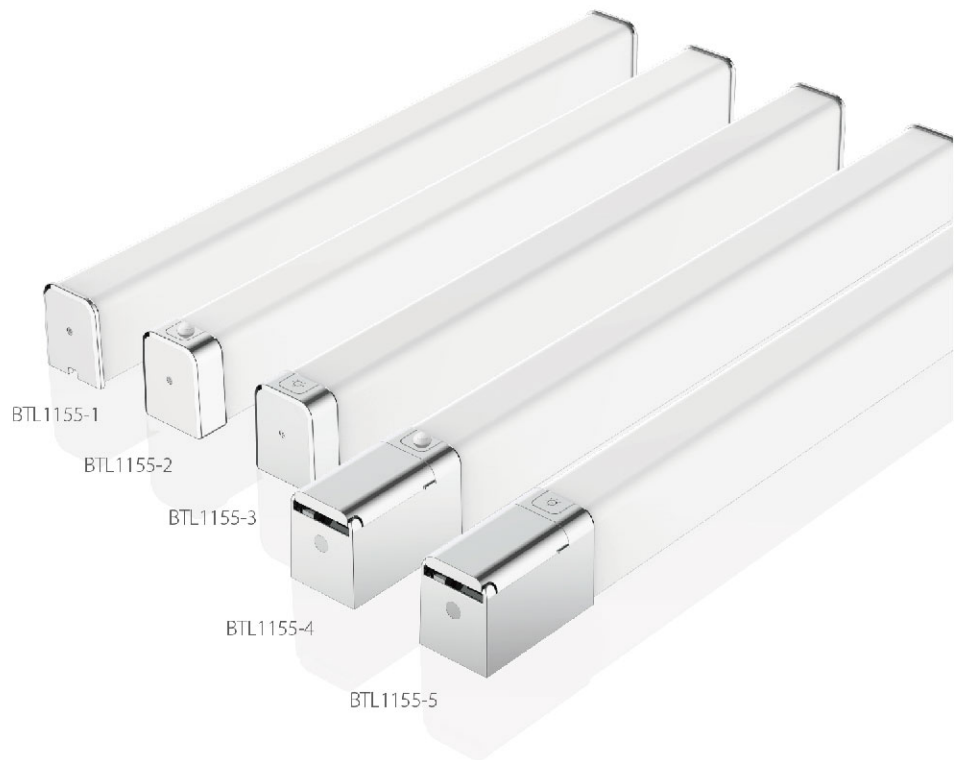

[Show details](#)



PIR sensory switch



Touch switch



With socket



Item No.	Voltage [V]	Wattage [W]	Lumen [lm]	Ra	PF	Life time [H]	Material	Size [LxWxHmm]	Packing [Pcs / M <sup>2</sup> / KG]
BTL1155-1	220-240	15	1200	≥80	>0.5	25000	PC+Alu.	600 * 53 * 65	20/0.036/6.8
BTL1155-1	220-240	20	1600	≥80	>0.5	25000	PC+Alu.	900 * 53 * 65	10/0.035/6.4
BTL1155-2	220-240	15	1200	≥80	>0.5	25000	PC+Alu.	600 * 53 * 65	20/0.036/6.8
BTL1155-2	220-240	20	1600	≥80	>0.5	25000	PC+Alu.	900 * 53 * 65	10/0.035/6.4
BTL1155-3	220-240	15	1200	≥80	>0.5	25000	PC+Alu.	600 * 53 * 65	20/0.036/6.8
BTL1155-3	220-240	20	1600	≥80	>0.5	25000	PC+Alu.	900 * 53 * 65	10/0.035/6.4
BTL1155-4	220-240	15	1200	≥80	>0.5	25000	PC+Alu.	600 * 53 * 65	20/0.036/6.8
BTL1155-4	220-240	20	1600	≥80	>0.5	25000	PC+Alu.	900 * 53 * 65	10/0.035/6.4
BTL1155-5	220-240	15	1200	≥80	>0.5	25000	PC+Alu.	600 * 53 * 65	20/0.036/6.8
BTL1155-5	220-240	20	1600	≥80	>0.5	25000	PC+Alu.	900 * 53 * 65	10/0.035/6.4

# Wall Lamps & Spot Lamps



BTL1100-A



BTL1102

IP44 Terminal Box

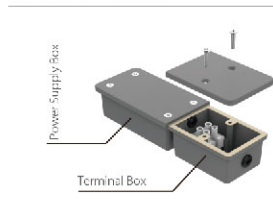

Item No.	Voltage [V]	Wattage [W]	Lumen [lm]	Ra	PF	Life time [H]	Material	Size [LxWxHmm]	Packing [Pcs / M <sup>2</sup> / KG]
BTL1100-A	220-240	8	640	≥80	>0.5	25000	PC+Alu.	400 * 121 * 42	20/0.062/4.6
BTL1100-A	220-240	12	960	≥80	>0.5	25000	PC+Alu.	600 * 121 * 42	20/0.091/6.2
BTL1102	220-240	8	520	≥95	>0.5	25000	PC+Alu.	400 * 67 * 151	20/0.087/8.0
BTL1102	220-240	12	780	≥95	>0.5	25000	PC+Alu.	600 * 67 * 151	20/0.129/11
BTL1102	220-240	15	980	≥95	>0.5	25000	PC+Alu.	800 * 67 * 151	20/0.167/13



# Wall Lamps & Spot Lamps

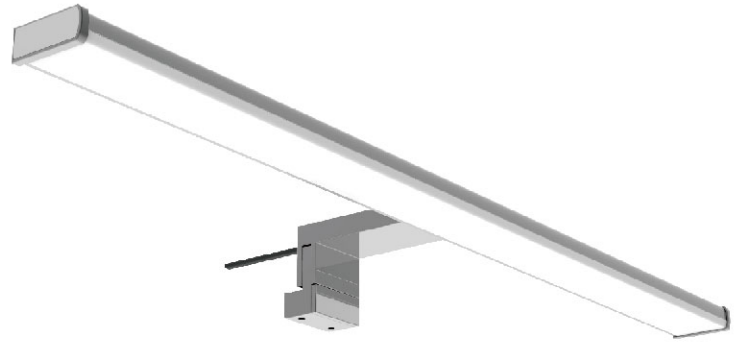

BTL1103-A

Installation



Color options



Silver

Black



BTL1004





















Item No.	Voltage [V]	Wattage [W]	Lumen [lm]	Ra	PF	Life time [H]	Material	Size [LxWxHmm]	Packing [Pcs / M <sup>2</sup> / KG]
BTL1103A	220-240	8	520	≥95	>0.5	25000	PC+Alu.	400 * 121 * 42	20/0.062/4.6
BTL1103A	220-240	12	780	≥95	>0.5	25000	PC+Alu.	600 * 121 * 42	20/0.091/6.2
BTL1103A	220-240	15	980	≥95	>0.5	25000	PC+Alu.	780 * 121 * 42	20/0.12/8.6
BTL1004	220-240	8	504	≥80	>0.5	25000	PC+Alu.	400 * 121 * 42	20/0.062/4.6
BTL1004	220-240	12	864	≥80	>0.5	25000	PC+Alu.	600 * 121 * 42	20/0.091/6.2
BTL1004	220-240	15	1080	≥80	>0.5	25000	PC+Alu.	780 * 121 * 42	20/0.12/8.6

# Wall Lamps & Spot Lamps



IP44 LVD   







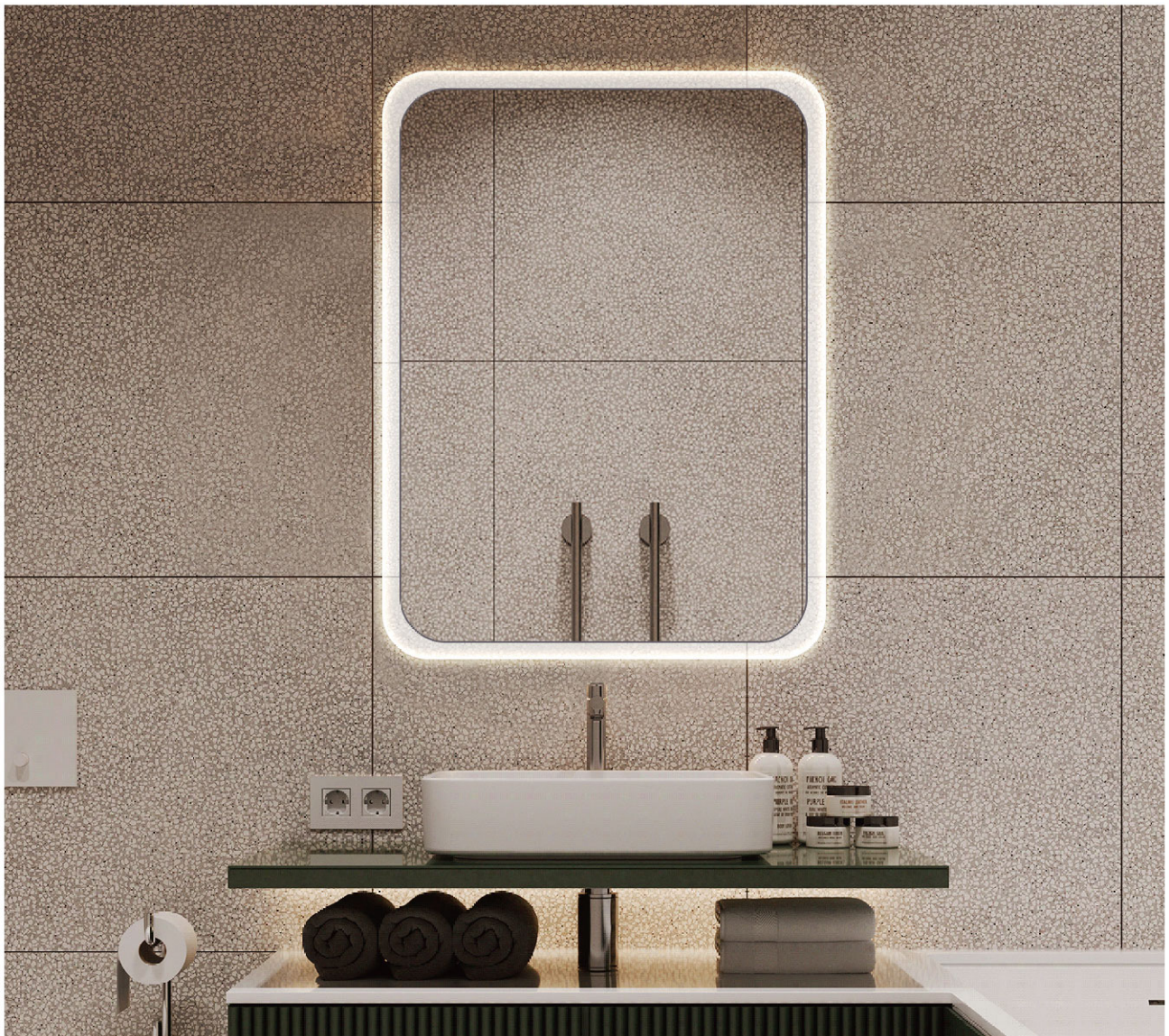





















Item No.	Switch	Function	Voltage [V]	Wattage [W]	Lumen [lm]	Ra	PF	Life time [H]	Size [WxHmm]
ML1015-1			220-240	12	780	≥95	>0.5	25000	600 * 800
ML1015-2			220-240	12	780	≥95	>0.5	25000	600 * 800
ML1015-3		 04:29	220-240	12	780	≥95	>0.5	25000	600 * 800
ML1015-4		 04:29 	220-240	12	780	≥95	>0.5	25000	600 * 800
ML1015-5		 04:29  	220-240	12	780	≥95	>0.5	25000	600 * 800
ML1015-6		 	220-240	12	780	≥95	>0.5	25000	600 * 800
ML1015-7		  	220-240	12	780	≥95	>0.5	25000	600 * 800



# Wall Lamps & Spot Lamps



IP44 LVD   

































Item No.	Switch	Function	Voltage [V]	Wattage [W]	Lumen [lm]	Ra	PF	Life time [H]	Size [WxHxmm]
ML1008-1			220-240	24	1000	≥80	>0.5	25000	500 * 700
ML1008-2			220-240	24	1000	≥80	>0.5	25000	500 * 700
ML1008-3		 04:29	220-240	24	1000	≥80	>0.5	25000	500 * 700
ML1008-4		 04:29  	220-240	24	1000	≥80	>0.5	25000	500 * 700
ML1008-5		 04:29   	220-240	24	1000	≥80	>0.5	25000	500 * 700
ML1008-6		 	220-240	24	1000	≥80	>0.5	25000	500 * 700
ML1008-7		  	220-240	24	1000	≥80	>0.5	25000	500 * 700
ML1008-8		  	220-240	24	1000	≥80	>0.5	25000	500 * 700
ML1008-9		  	220-240	24	1000	≥80	>0.5	25000	500 * 700



# Wall Lamps & Spot Lamps



IP44 LVD   

Item No.	Switch	Function	Voltage [V]	Wattage [W]	Lumen [lm]	Ra	PF	Life time [H]	Size [WxHmm]
ML1009-1			220-240	17	700	≥80	>0.5	25000	900 * 700
ML1009-2			220-240	17	700	≥80	>0.5	25000	900 * 700
ML1009-3		 04:29	220-240	17	700	≥80	>0.5	25000	900 * 700
ML1009-4		 04:29  	220-240	17	700	≥80	>0.5	25000	900 * 700
ML1009-5		 04:29   	220-240	17	700	≥80	>0.5	25000	900 * 700
ML1009-6		  18-19%	220-240	17	700	≥80	>0.5	25000	900 * 700
ML1009-7		  18-19%   18-19%	220-240	17	700	≥80	>0.5	25000	900 * 700
ML1009-8		  18-19%   18-19%	220-240	17	700	≥80	>0.5	25000	900 * 700
ML1009-9		  18-19%   18-19%	220-240	17	700	≥80	>0.5	25000	900 * 700

# Cabinet Lights



## IP20

### Product Function:

- Sensing Range: 0-15lux.
- Human body sensing distance: 3-6 meters, 120°, delay 20 seconds.
- Accessories: 2 magnetic primer, 1 double-sided tape.

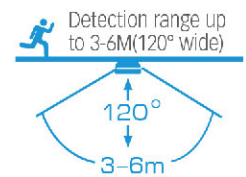

### Product Details:



### Application installation



Item No.	Battery	Wattage [W]	Lumen [lm]	Ra	LED	IP	Material	Size [LxWxHmm]	Packing [Pcs / M <sup>2</sup> / KG]
KL2006	4*AAA(no include)	0.6	21	80	SMD2835	20	ABS	237*31*18	100/0.021/6.5

# Cabinet Lights



KL2000



KL2001



Item No.	LED Lamp Beads	Battery [no include]	Wattage [W]	Control	Material	Size [DxHmm]	Packing [Pcs / M <sup>3</sup> / KG]
KL2000	3PCS SMD2835+1PCS RGB	3*AAA	LED 0.45W	press/Infrared remote	ABS	62*32	100/0.019/4.5
KL2001	6PCS SMD2835+1PCS RGB	3*AA	LED 0.6W	press/Infrared remote	ABS	76.5 * 32	100/0.031/6.6



KL2002



KL2003

Item No.	Color Temp. [K]	Battery [no include]	Wattage [W]	Control	Material	Size [DxHmm]	Packing [Pcs / M <sup>3</sup> / KG]
KL2002	3000/4000/6500	3*AAA	LED 0.5W 6PCS	Body induction/Light control	ABS	80*20	100/0.025/7
KL2003	3000/4000/6500	3*AA	LED 0.5W 6PCS	Body induction/Light control	ABS	76.5*32	100/0.03/6.5

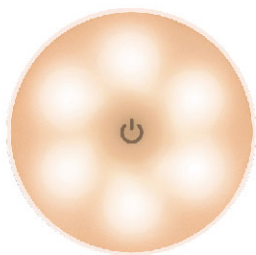

KL2004



KL2005

Item No.	Color Temp. [K]	Battery	Wattage [W]	Control	Material	Size [DxHmm]	Packing [Pcs / M <sup>3</sup> / KG]
KL2004	3000/4000/6500	500 mah lithium battery	LED 0.5W 6PCS	Body induction/Light control	ABS	80*19	100/0.025/7.5
KL2005	3000/4000/6500	500 mah lithium battery	LED 0.5W 6PCS	Body induction/Light control	ABS	80*80*19	100/0.025/7.5